	<b>SUPPLY SIDE INTERCONNECTION REQUIREMENTS FOR DISTRIBUTED GENERATION</b>	<b>094670</b>
	<b>Asset Type:</b> Electric Metering	<b>Function:</b> Construction
<b>Issued by:</b> Albert Pham (A1P5) <i>albert Pham</i>	<b>Date:</b> 9-15-20	
<b>Rev. #00:</b> This is a new document. This document replaces PG&E Bulletin TD-6999B-048, "Requirements for Line Side Interconnections for Distributed Generation". For a description of changes, see See Page 7.		

**Purpose and Scope**

This document describes interconnection requirements for Net Energy Metering (NEM) projects where a supply side interconnection is requested by Distributed Generation (DG) customers on 0 – 600 Volt meter panels and switchboards. A supply side interconnection is defined as a connection between the PG&E electric meter and the main service disconnect / breaker. For Virtual Net Energy Metering (VNEM) projects where the proposed interconnection is on the line side of the PG&E meter, refer to [Document 076249](#).

References	Location	Document
<a href="#">Virtual Net Energy Metering Installation</a> . . . . .	<a href="#">OH: Meters/UG-1 Services/Greenbook</a>	<a href="#">076249</a>
<a href="#">Disconnect Switch Requirements for Distributed Generation Customers</a> . . . . .	<a href="#">Greenbook</a> . . . . .	<a href="#">060559</a>

**General Information**

PG&E’s preferred distributed generation interconnection is on the load side of the panel, after the service main disconnect. This interconnection is described in National Electrical Code (NEC) 705.

For supply side interconnections, the following requirements apply:

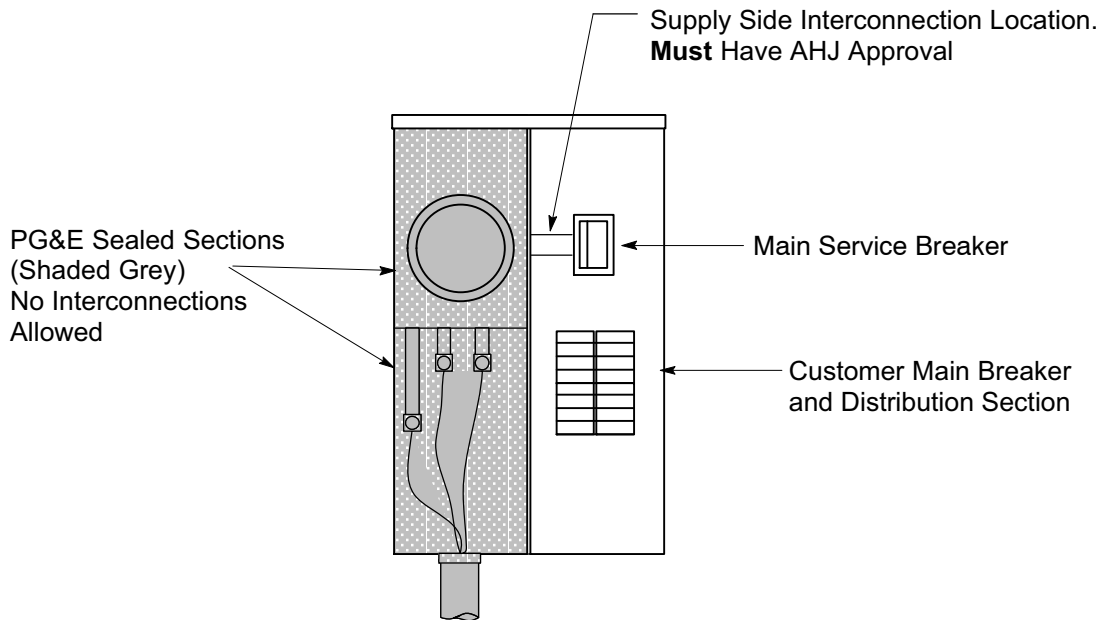
1. The interconnection must be between the PG&E Meter and main breaker in the customer’s section of the equipment and not in the PG&E termination, metering, or other sealed compartment or section.
2. PG&E recommends the interconnection proposal and single line diagrams are pre-approved by their Authority Having Jurisdiction (AHJ).
3. The AHJ must sign off the building permit for the generation system before PG&E will give the final approval to operate.
4. Residential “solar ready” service panels designed with a dedicated alternative energy (customer generation) circuit breaker on the supply side of the main breaker is allowable. “Solar ready” panels must be PG&E and EUSERC approved and have factory installed labels showing location and ratings of the generation source.
5. New pad-mounted (floor-standing) switchboards must have a separate compartment / section dedicated for supply side connections. Or, the switchboard manufacturer may design and install provisions for a supply side connection prior to the switchboard being installed and energized.

**Specific Requirements**

1. When requesting to propose a supply side interconnection, submit the following to the PG&E Electric Generation Interconnection (EGI) department:
  - A. Single line diagram clearly showing the supply side interconnection.
  - B. Photos of the service panel.
    - 1.Photos must show the whole service panel and all switchboard sections, no close-up photos.
    - 2.Photos must be marked-up to show where the interconnection will be and how conductors will be routed to the Interconnection Location.

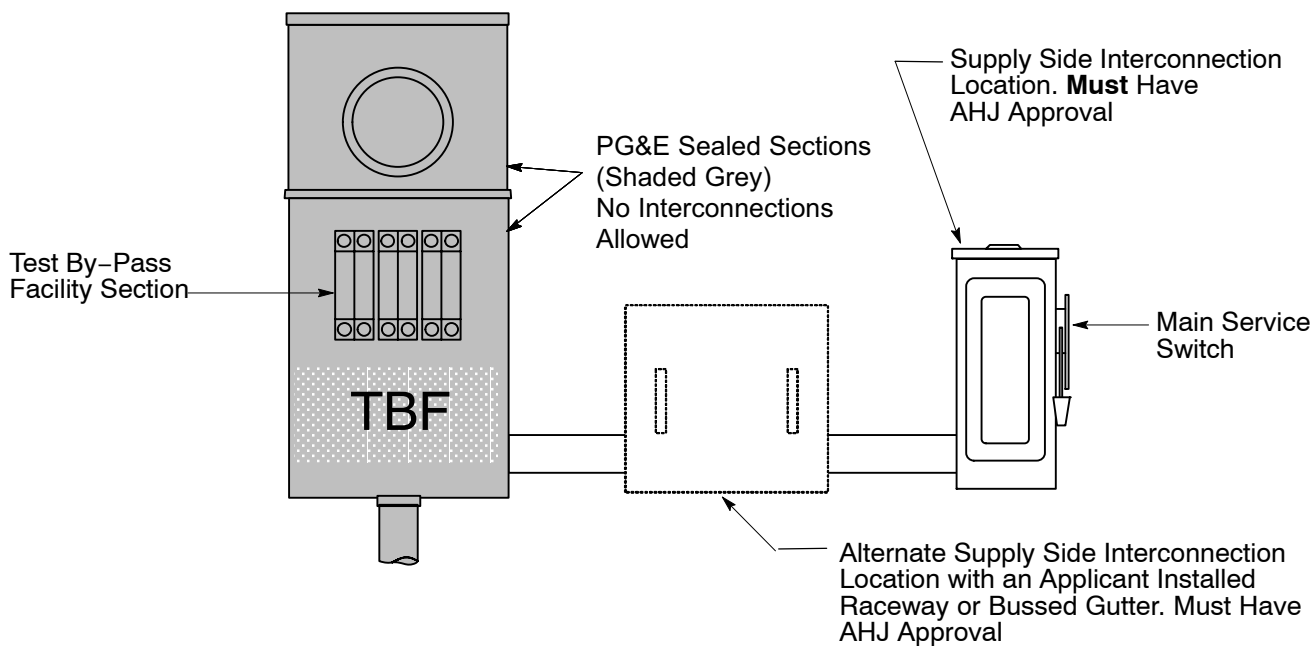
## Supply Side Interconnection Requirements for Distributed Generation

2. Do not route conduit and/or conductors through any PG&E sealed sections for the purpose of interconnection.
3. A fused AC disconnect switch must be installed within 10 feet and line of sight to the PG&E meter. Refer to [Document 060559](#) for AC disconnect requirements.
4. Figure 1 – Figure 7 on Pages 2 – 7 distinguishes the separation between PG&E and customer sections and the designated Supply Side Interconnection Locations. Interconnections are not allowed in any PG&E sections (shaded grey).

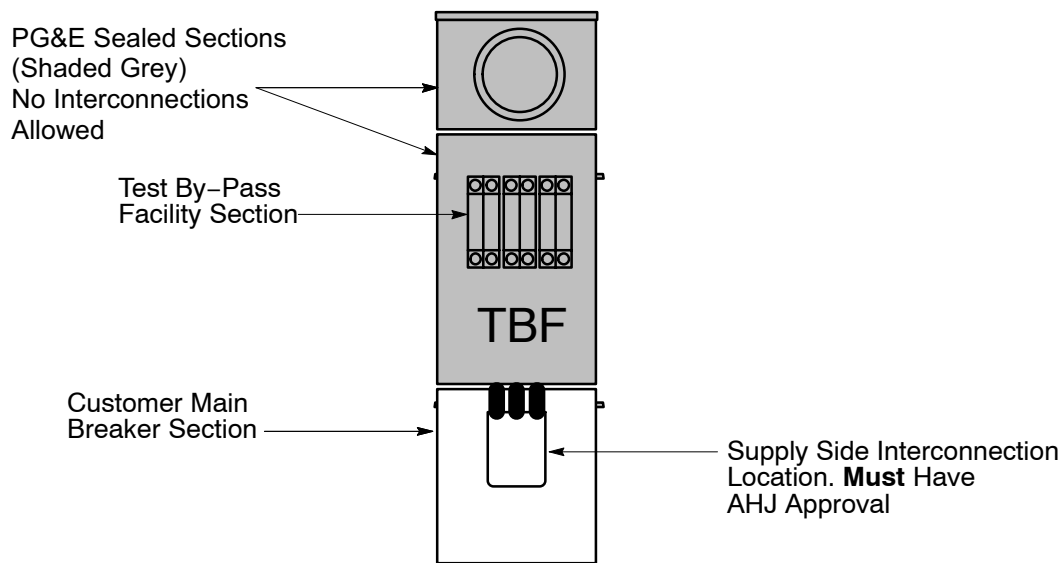


**Figure 1**  
**Residential Wall-Mount Service Panel**  
**Interconnections are not allowed in any PG&E sections (shaded grey)**

# Supply Side Interconnection Requirements for Distributed Generation

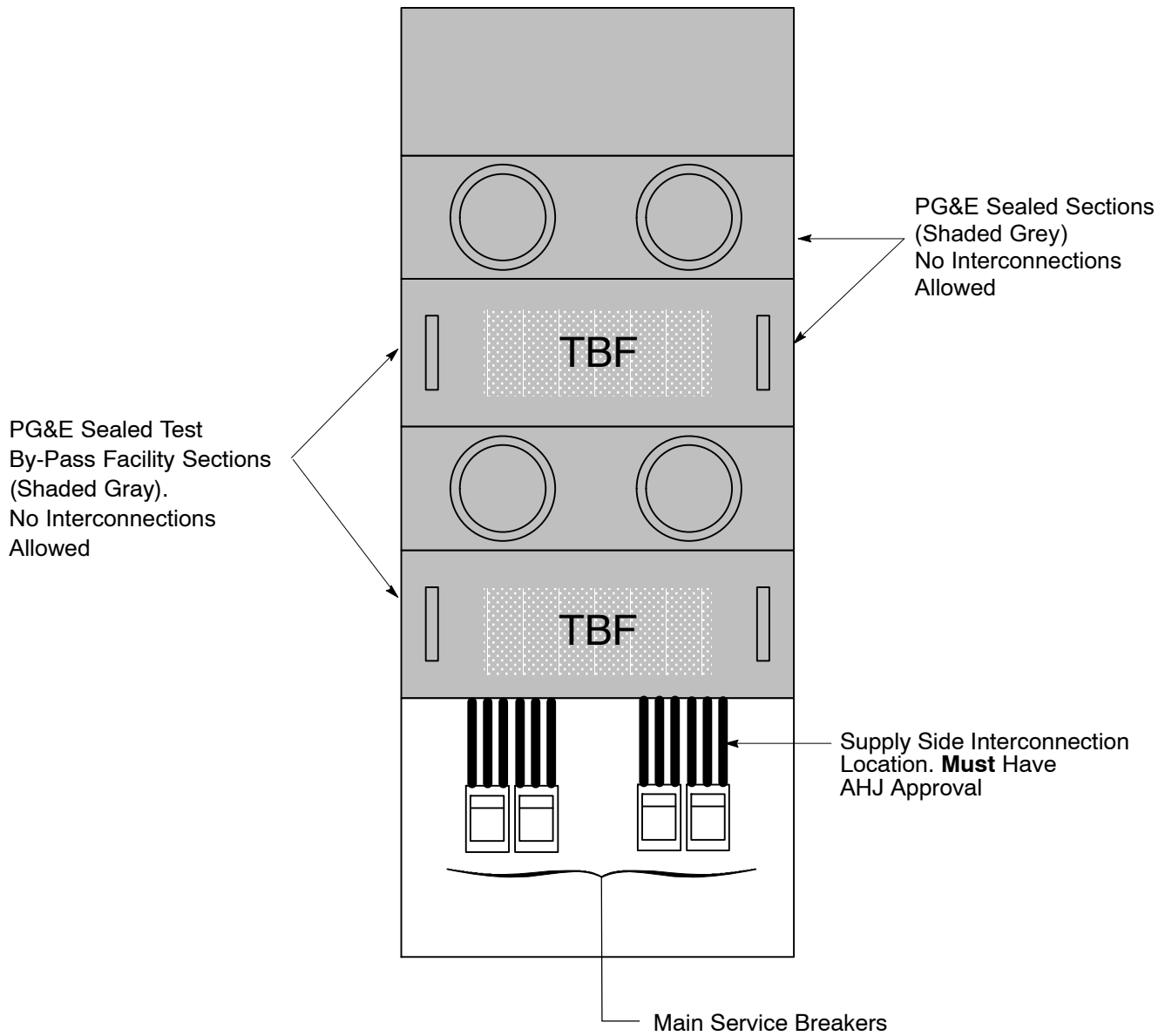


**Figure 2**  
**Commercial Wall-Mount Service Panel**



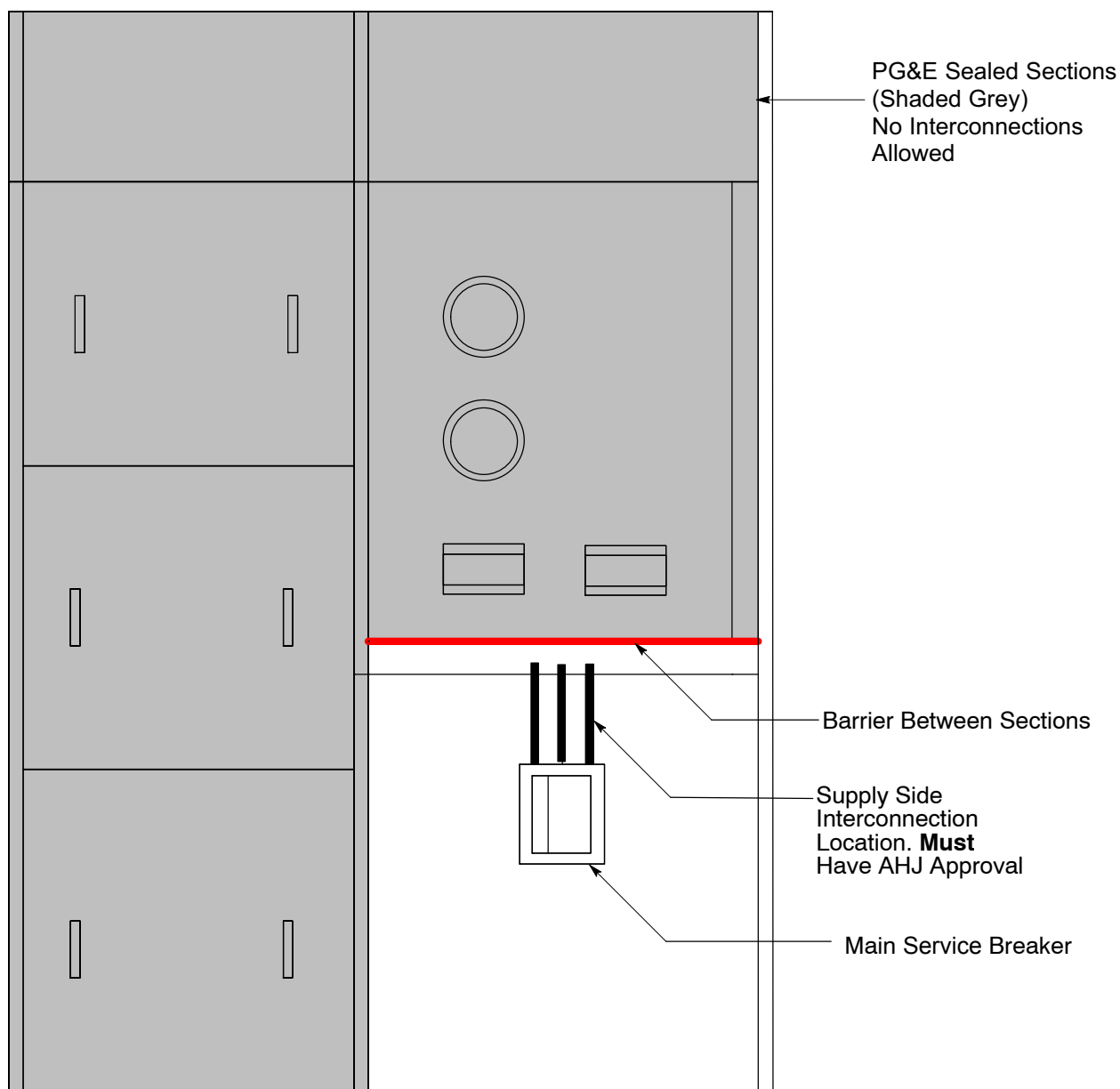
**Figure 3**  
**Commercial Wall-Mount Meter Breaker Combination Service Panel**  
Interconnections are not allowed in any PG&E sections (shaded grey)

# Supply Side Interconnection Requirements for Distributed Generation



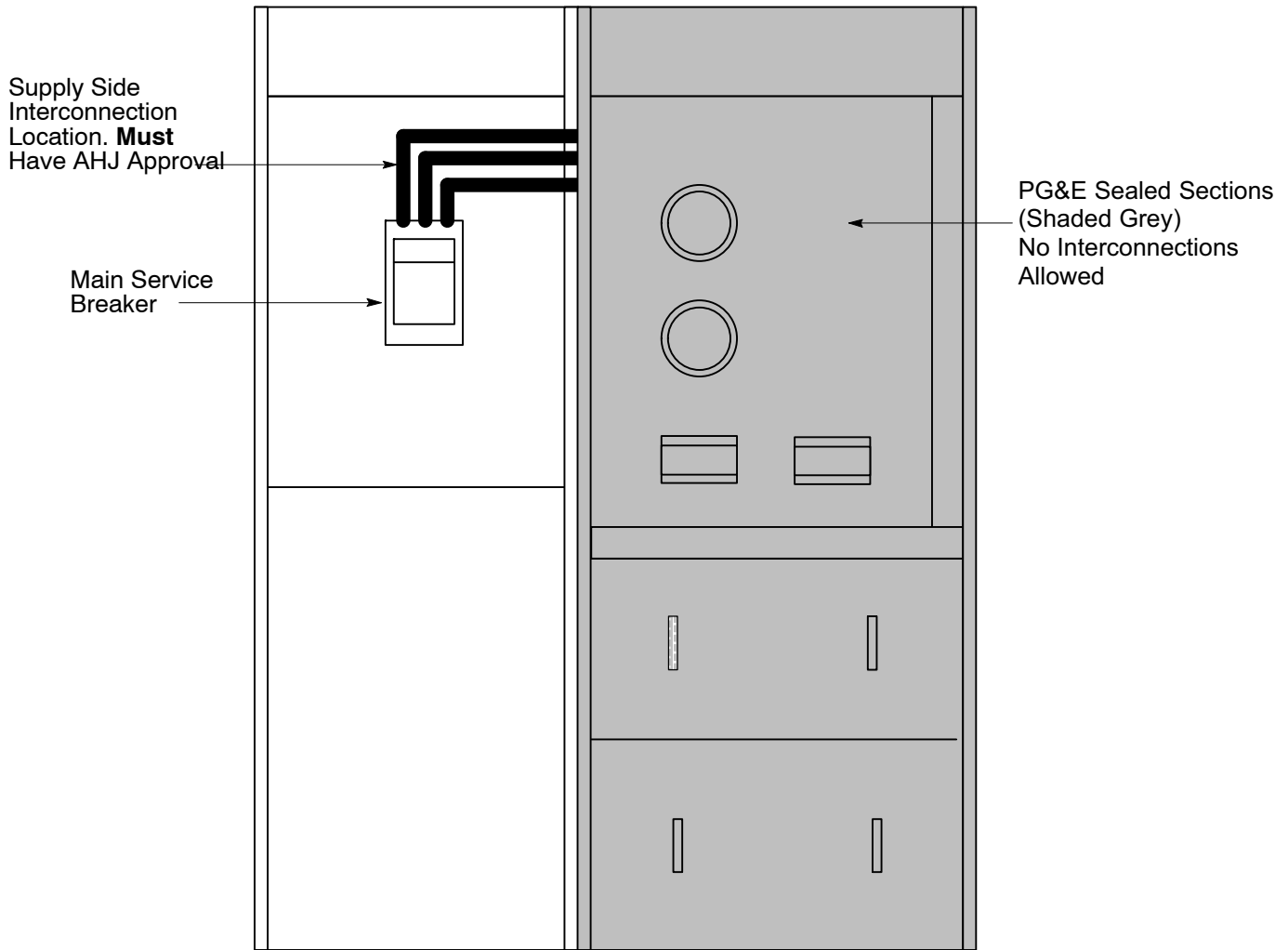
**Figure 4**  
**Commercial Floor-Standing Multi-Meter Switchboard**  
Interconnections are not allowed in any PG&E sections (shaded grey)

# Supply Side Interconnection Requirements for Distributed Generation



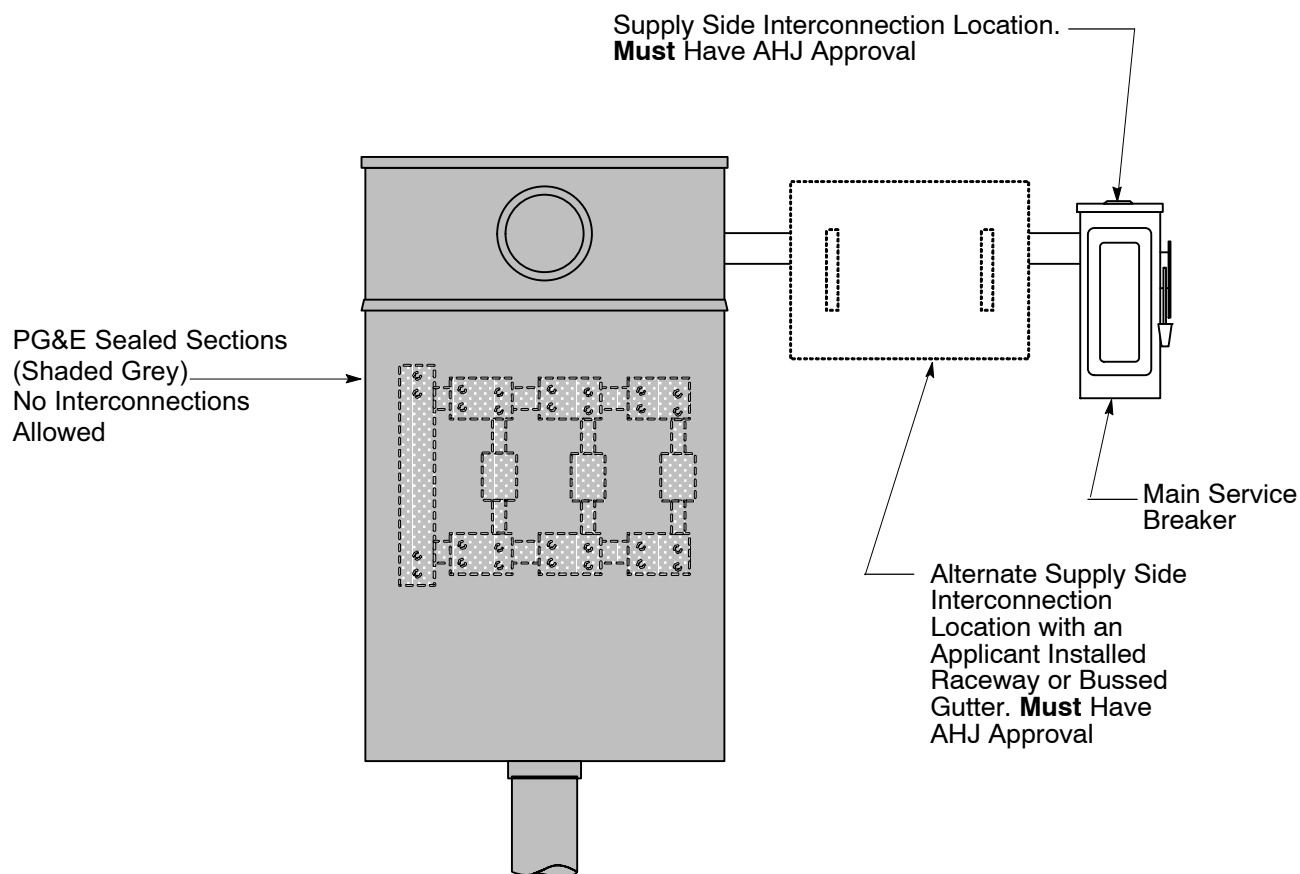
**Figure 5**  
**Floor Standing Switchboard With Metering Section Above the Main Breaker**  
**Interconnections are not allowed in any PG&E sections (shaded grey)**

# Supply Side Interconnection Requirements for Distributed Generation



**Figure 6**  
**Floor Standing Switchboard With Metering Section Above the Service Termination Section**  
Interconnections are not allowed in any PG&E sections (shaded grey)

## Supply Side Interconnection Requirements for Distributed Generation



**Figure 7**  
**Wall Mounted and Current Transformer Cabinet**  
**Interconnections are not allowed in any PG&E sections (shaded grey)**

### Revision Notes

Revision 00 has the following changes:

1. This is a new document. This document replaces PG&E Bulletin TD-6999B-048, "Requirements for Line Side Interconnections for Distributed Generation".