



*Pacific Gas and  
Electric Company®*

# Pacific Gas and Electric Company

## EPIC Final Report

### **Program**

***Electric Program Investment Charge (EPIC)***

### **Project**

***EPIC 1.14 – Next Generation SmartMeter™  
Telecom Network Functionalities***

### **Department**

Electric Asset Management: Emerging Grid Technologies

### **Line of Business Lead**

Tom Martin

### **Line of Business Sponsor**

Ferhaan Jawed

### **Contact**

EPIC\_Info@PGE.com

### **Date**

November 30, 2016

### **Version Type**

Final

## Table of Contents

<b>1</b>	<b>Executive Summary</b>	<b>1</b>
<b>2</b>	<b>Introduction</b>	<b>5</b>
2.1	Program Regulatory Background	5
<b>3</b>	<b>Project Summary</b>	<b>6</b>
3.1	Objective	6
3.2	Opportunities Addressed	6
<b>4</b>	<b>Project Initiatives: Results, Findings, and Recommendations</b>	<b>7</b>
4.1	Demonstrating the Capabilities of the SmartMeter™ Network	7
4.1.1	SmartMeter™ Network Bandwidth	7
4.1.2	SmartMeter™ Network Coverage Visualization	12
4.1.3	SmartMeter™ Network Support for Smart Grid Devices and Applications	13
4.2	Leveraging the SmartMeter™ Network for Smart Grid Devices and Applications	15
4.2.1	Smart Streetlights	15
4.2.2	SmartPole Demonstration Project	16
4.2.3	Next Generation Network Hardware	18
4.2.4	Using the SmartMeter™ Network for Distribution Automation Communications	20
4.2.5	Transformer Monitoring	23
4.2.6	SmartMeter™ Voltage Data Collection	24
4.2.7	SmartMeter™ Data for Phase Identification	27
4.3	Enhancing the SmartMeter™ System for Outage Reporting	29
4.3.1	Outage Reporting and Logging	29
4.3.2	Outage Data for Major Storms	38
<b>5</b>	<b>Project Key Results and Conclusions</b>	<b>41</b>
5.1	Data Access	43
5.2	Value Proposition	43
5.2.1	Primary Principles	43
5.2.2	Secondary Principles	44
5.3	Technology Transfer Plan	44
5.3.1	IOU's Technology Transfer Plans	44
5.3.2	Adaptability to Other Utilities / Industry	45
<b>6</b>	<b>Metrics</b>	<b>46</b>
<b>7</b>	<b>Conclusion</b>	<b>50</b>
<b>8</b>	<b>Glossary</b>	<b>51</b>
	<b>Appendix A – Technical Specification Sheet for the GoT™ SmartPole Meter</b>	<b>53</b>

## List of Tables

Table 4-1. Voltage Monitoring Comparison .....	27
Table 6-1. EPIC Project Metrics for Potential Benefits .....	46

## List of Figures

Figure 1. EPIC 1.14 Project Tracks and Initiatives.....	6
Figure 2. Average Network Throughput (kbps) Downlink .....	8
Figure 3. Average Network Throughput (kbps) Uplink .....	9
Figure 4. Network Statistics, Medium Density AP .....	10
Figure 5. Hop Count Totals, Average .....	10
Figure 6. Latency Times, Medium Density AP .....	11
Figure 7. Network Node Visualization .....	12
Figure 9. Average Network Throughput (kbps) Comparison – Downlink .....	16
Figure 8. Average Network Throughput (kbps) Comparison – Uplink.....	16
Figure 10. Traditional Pedestal and Pole Mount Meters .....	17
Figure 11. SmartPole Meter (identified With Red Arrow) .....	17
Figure 12. DA Communications Test Setup .....	21
Figure 13. High Frequency Voltage Collection Network Impact .....	26
Figure 14. Last Gasp Receipt During Major Outage.....	32
Figure 15. Restoration Message Receipt as the Network Is Self-Healing .....	35
Figure 16. Restoration Dashboard.....	39
Figure 17. Nested Outage .....	39

---

## 1 Executive Summary

This report details the achievements and findings of Pacific Gas and Electric Company's (PG&E) Electric Program Investment Charge (EPIC) Project 1.14 Next Generation SmartMeter™ Telecom Network Functionalities. In this project, PG&E demonstrated that the Electric SmartMeter™ Telecommunications Network (SMN) can potentially support a wide variety of both present and future smart grid applications and devices.

The primary purpose of this project was to demonstrate new ways to leverage the SMN. PG&E chose to focus on technologies that have the potential to provide the greatest benefit to PG&E customers and utility operations today. These technologies have the potential to provide energy and cost savings, enhance safety, and better support the electrical system. The project included a number of distinct initiatives that fell into three overall categories or project tracks:

1. *Demonstrating the Capabilities of the SmartMeter™ Communications Network*: Establishing baseline information about current usage of the SMN, and visualizing network coverage strength.
2. *Leveraging the SmartMeter™ Network for Smart Grid Devices and Applications*: Testing the use of the SMN to enable communications between several new types of smart grid equipment.
3. *Enhancing the SmartMeter™ System for Outage Reporting*: Using outage reporting data from the SMN to better identify outages and share information with distribution management systems more effectively.

### **Demonstrating the Capabilities of the SmartMeter™ Communications Network (4.1)**

As smart grid technologies evolve and become more ubiquitous, PG&E's SMN could be a valuable communications channel for other devices and applications beyond the original scope for which the system was built. This project track demonstrated that on average, current network usage for the current set of AMI operations comprises only 15-20% of the average available bandwidth, and that additional data can be routed on the SMN without impact to current operations. This track also identified ways to visualize the network coverage strength using maps to more easily manage aspects of the network.

As a result of these initiatives, PG&E has demonstrated the SMN's capabilities to justify further field testing in other Smart Grid projects. PG&E has adopted the network analysis methods used in this EPIC project to evaluate the SMN to ensure that any new devices and applications that use the SMN will not negatively impact the network or create any cyber security risks. These findings are relevant to other utilities that use the same AMI networking infrastructure, and PG&E has shared the results at networking user group meetings.

### **Leveraging the SmartMeter™ Network for Smart Grid Devices and Applications (4.2)**

This project demonstrated proof of concept for a number of network applications and devices that might leverage and improve the SMN:

- **Smart Streetlights (4.2.1)**

Streetlights today are equipped with photocells that turn the streetlight on or off depending on the amount of ambient light. Photocells are now available that contain Network Interface Cards (NICs) that are compatible with PG&E's SMN. This project initiative demonstrated the ability of these networked photocells to operate in PG&E's environment. These photocells were tested in the laboratory and demonstrated in the field, and were shown to provide the ability to remotely control streetlights, send alerts when the streetlight malfunctions, and provide accurate kWh measurements for billing purposes. The ability to identify "day burners" – streetlights that don't turn off during the day – can provide savings to PG&E customers. In addition, network-capable photocells were shown to have the potential to strengthen the SMN by providing additional network nodes that are elevated and can transmit wireless

signals better than SmartMeter™ devices at ground level. This can provide a cost-effective way to strengthen the SMN, and could be a particular advantage in locations where the meter population is sparse and the network coverage is weak. As a result of this successful EPIC demonstration, PG&E is evaluating the business case for a wider field test installation of SMN-compatible photocells into its LED Streetlight Replacement project, which may benefit PG&E customers, improves public safety, and benefits the environment.

- **SmartPoles (4.2.2)**

In a demonstration project partnership with the City of San Jose, small-footprint SmartMeter™ devices were installed in fifty 4G/LTE-enabled SmartPoles in the downtown area to provide accurate metering for the City’s telecom equipment. This small-footprint meter provides an aesthetically-pleasing, integrated metering option that can enable PG&E to accurately measure electricity use by civic and corporate telecommunications customers. Currently these customers are billed at a flat rate or not at all. This project initiative demonstrated that these meters, which were installed on top of a SmartPole and blend seamlessly into the environment, can provide accurate kWh billing and transmit usage information at the same cadence as other SmartMeter™ devices. Adoption and scaling up of this technology to commercial scale would allow these customers to receive more accurate billing, and offers the potential to strengthen the SMN in the same manner as Smart Streetlights through elevated network nodes.

- **Next Generation Network Hardware (4.2.3)**

Newer network hardware (the NICs in PG&E’s SmartMeters™, network Relays, and Access Points that transmit data to the data center) provides faster throughput – up to 300kbps – and the ability to provide seamless backward compatibility with older network hardware. In 1-hop network tests, the throughput was shown to be up to five times greater than the throughput in older devices tested during network baseline assessment. This project initiative demonstrated that these devices can potentially be integrated into the current network and identified situations where they may help to improve and strengthen the existing SMN. As a result of this successful EPIC demonstration, PG&E has increased confidence that newer network hardware, if fully scalable, will not adversely impact the SMN, and indeed could strengthen it.

- **Distribution Automation (4.2.4)**

This project initiative demonstrated network hardware<sup>1</sup> and applications that enable distribution Supervisory Control And Data Acquisition (SCADA) equipment to use PG&E’s SMN for communications. This has the potential to provide a lower-cost option for connecting and communicating with SCADA equipment and can help to reduce congestion on the existing communications infrastructure used for distribution automation. As a result of this successful EPIC demonstration, PG&E has obtained useful data on the potential to reduce both network congestion and telecommunications costs, and may consider further testing and demonstration of such capabilities. The ability to use the same network Relays as the SMN for distribution automation is significant for other utilities as well, and PG&E has shared the findings of this successful demonstration with utilities that use the same networking technology.

---

<sup>1</sup> It should be noted that this was the only initiative in this EPIC project that demonstrated new communication hardware that required cyber security review. All other devices demonstrated used communication hardware that had previously passed PG&E cyber security review.

- **Transformer Monitoring (4.2.5)**

Traditional transformer monitoring technologies are not cost-effective for monitoring small transformers. This initiative demonstrated a potential commercially-available solution for monitoring smaller transformers using the SMN for communications, providing a relatively low-cost means to monitor unit substation, auto transformer, and major customer transformers. This project initiative also developed and tested a very low-cost transformer temperature monitoring device using off-the-shelf components that can communicate with the SMN. This demonstrated the potential to provide cost-effective monitoring for even-smaller residential transformers using the open source networking abilities of the SmartMeter™ NIC. As a result of this successful EPIC demonstration, PG&E recognizes that SMN-based transformer monitoring is an emerging technology worth testing and evaluating further, to enhance both system reliability and public safety.

- **Voltage Data Collection (4.2.6)**

Collecting granular voltage readings throughout PG&E's service territory can help improve grid operations and higher-level automation and optimization applications. This project initiative demonstrated several methods of collecting voltage data and power quality information from SmartMeter™ devices. Key tasks included: developing use cases for voltage collection data across PG&E departments, researching the various methods for collecting voltage data from SmartMeter™ devices, and identifying collection methods for each use case. This work determined that for most use cases, reprogramming SmartMeter™ devices to include voltage reads on a per-interval basis offers the greatest benefit spanning the entire meter population with the least impact on network traffic, and at the lowest cost. This EPIC demonstration provides a potentially scalable, consistent methodology for monitoring SmartMeter™ voltage data, which PG&E may consider and test for other projects that require voltage data.

- **Phase Identification (4.2.7)**

This initiative demonstrated the potential ability to identify customer phase using the voltage data collected by SmartMeter™ devices. In certain situations, phase can be identified using voltage regulation at the substation to individually raise and lower the power on each phase, and reviewing the voltage data collected by SmartMeter™ devices. This represents a first step towards identifying customer phase using SmartMeter™ data and provided initial data to support potentially exploring more challenging use cases as part of the *EPIC 2.14 Automatically Map Phasing Information* project. If a scalable ability to automatically determine the phase(s) for individual customers becomes commercially available, PG&E may be able to better manage and maintain the electric grid.

### **Enhancing the SmartMeter™ System for Outage Reporting (4.3)**

The existing SmartMeter™ system can be a valuable resource for quickly and accurately identifying outages. The following set of EPIC 1.14 initiatives were designed to further validate that SmartMeter™ outage data is accurate, reliable, timely, and complete. In addition, this track demonstrated ways to extend the use of existing SmartMeter™ outage data and functionality to enable faster restoration during major storm events and evaluate possible enhancements to the system.

- **Outage Reporting and Logging (4.3.1)**

This initiative analyzed outage data over a period spanning 29 months (including over 900,000 outage events) to analyze the accuracy, reliability, and timeliness of SmartMeter™ outage data, and also developed recommendations for additional improvements to PG&E's SmartMeter™ system for its existing outage reporting and notification system.

- **Outage Reporting During Major Storm Events (4.3.2)**

This initiative demonstrated the ability to use outage data from SmartMeter™ devices to develop a prototype *Restoration Dashboard* application that can display outage restorations in real time and identify nested outages displayed on a map. This project also demonstrated a side-by-side data analysis for storm restoration events comparing the data from SmartMeter™ devices against PG&E's distribution outage tracking system. The results indicate that SmartMeter™ outage data can provide both a finer degree of granularity in tracking which customers are affected by an outage, and more detailed calculations of the outage duration.

As a result of the EPIC 1.14 Outage initiatives, PG&E has gained additional insights into using existing SmartMeter™ outage data and functionality to enhance outage identification and restoration efforts which enables faster service restoration and enhanced safety and reliability. PG&E's work to validate the accuracy of meter outage data has significance for the entire industry, in particular for utilities that use the same network technology; and these findings have been shared with other utilities at industry conferences and user group meetings.

### **Conclusion**

PG&E has invested in a robust AMI network and has connected more than 5 million AMI devices across its electric network. The Electric SmartMeter™ Network is working as designed and is delivering substantial benefits in many areas including meter-reading savings, outage notification, faster restoration following outages, power theft identification, and more. As Smart Grid technology evolves, PG&E's SmartMeter™ Network must evolve as well.

While the primary functions of the SmartMeter™ Network are to support these day-to-day metering and outage management operations, the EPIC 1-14 project demonstrated that the metering and existing outage information functions only use about 15-20% of its available bandwidth. This project has shown that there is significant bandwidth available in the network, and that if scalable it potentially could support advanced Smart Grid devices and applications. These findings have industry-wide significance, and have been shared with other utilities that use the same networking technology.

As a result of the achievements of this project, PG&E has gained insights which may help further testing and demonstration to:

- Leverage the SMN for Smart Grid devices and applications that have the potential to increase reliability and lower costs.
- Consider deploying Smart Streetlights and low-footprint metering solutions.
- Explore devices that can use the SMN to help monitor the electric distribution system.
- More deeply explore initiatives that leverage SmartMeter™ voltage measurement data, such as exploring algorithmic Phase Identification through an EPIC 2 project.
- Make better use of SmartMeter™ outage reporting and logging to immediately identify outages and accurately determine restoration actions in the field.

This project further validated that PG&E's investment in its SmartMeter™ telecommunications network has the potential to provide value to the company and to customers both today and well into the future.

## 2 Introduction

This report documents the *EPIC 1.14 – Next Generation SmartMeter™ Telecom Network Functionalities* project achievements, highlights key learnings from the project that have industry-wide value, and identifies future opportunities for PG&E to leverage these technologies. Through the PG&E EPIC Program Annual Report process, PG&E has kept CPUC staff and stakeholders informed on the progress of the project. The following is PG&E’s final report on this project.

### 2.1 Program Regulatory Background

The California Public Utilities Commission (CPUC) passed two decisions that established the basis for the EPIC program. The CPUC initially issued D. 11-12-035, *Decision Establishing Interim Research, Development and Demonstrations and Renewables Program Funding Level*<sup>2</sup>, which established the Electric Program Investment Charge (EPIC) on December 15, 2011. Subsequently, on May 24, 2012, the CPUC issued D. 12-05-037, *Phase 2 Decision Establishing Purposes and Governance for Electric Program Investment Charge and Establishing Funding Collections for 2013-2020*<sup>3</sup>, which authorized funding in the areas of applied research and development, technology demonstration and deployment (TD&D), and market facilitation. In this later decision, CPUC defined TD&D as “the installation and operation of pre-commercial technologies or strategies at a scale sufficiently large and in conditions sufficiently reflective of anticipated actual operating environments to enable appraisal of the operational and performance characteristics and the financial risks associated with a given technology”<sup>4</sup>.

The decision also required the EPIC Program Administrators<sup>5</sup> to submit Triennial Investment Plans to cover three-year funding cycles for 2012-2014, 2015-2017, and 2018-2020. On November 1, 2012, in A.12-11-003, PG&E filed its first triennial Electric Program Investment Charge (EPIC) Application at the CPUC, requesting \$49,328,000 including funding for 26 Technology Demonstration and Deployment Projects. On November 14, 2013, in D.13-11-025, the CPUC approved PG&E’s EPIC plan, including \$49,328,000 for this program category.

Pursuant to PG&E’s approved EPIC triennial plan, PG&E initiated, planned, and implemented the following project: *1.14 – Next Generation SmartMeter™ Telecom Network Functionalities*. Through the annual reporting process, PG&E kept CPUC staff and stakeholders informed on the progress of the project.

---

<sup>2</sup> [http://docs.cpuc.ca.gov/PublishedDocs/WORD\\_PDF/FINAL\\_DECISION/156050.PDF](http://docs.cpuc.ca.gov/PublishedDocs/WORD_PDF/FINAL_DECISION/156050.PDF).

<sup>3</sup> [http://docs.cpuc.ca.gov/PublishedDocs/WORD\\_PDF/FINAL\\_DECISION/167664.PDF](http://docs.cpuc.ca.gov/PublishedDocs/WORD_PDF/FINAL_DECISION/167664.PDF).

<sup>4</sup> Decision 12-05-037 p. 37.

<sup>5</sup> Pacific Gas & Electric (PG&E), San Diego Gas & Electric (SDG&E), Southern California Edison (SCE), and the California Energy Commission (CEC).



## **3 Project Summary**

### **3.1 Objective**

PG&E has installed a telecommunications network to transfer data from SmartMeter™ devices to PG&E's billing systems. While the primary purpose of the SmartMeter™ Network (SMN) is to transmit metering data from the customer's meter to the back office, the mesh portion of the network (the meters, Relays, and Access Points that connect to the cellular backhaul network) could have potential as a resource for supporting future smart grid efforts.

The objective of this project was threefold: to analyze the capacity and capabilities of the Electric SMN, demonstrate proofs of concept that certain new smart grid devices and applications might function on the network, and identify methods to extend and improve the outage messaging capabilities already built into the system.

### **3.2 Opportunities Addressed**

PG&E has invested over \$2 billion in a robust Advanced Metering Infrastructure (AMI) network for electric and gas. PG&E's Electric SMN is one of the largest private IPv6 networks in the world, and has connected more than 5 million AMI devices across its electric network. The SMN that has been deployed as part of PG&E's smart grid is working as designed and is delivering value in many areas including meter-reading savings, outage notification, faster restoration following outages, power theft identification, and more. However, PG&E designed and built the SMN to accommodate future non-AMI applications once successfully tested, piloted, and funded.

Smart grid technologies continue to evolve as utilities deploy different components, develop new technologies, and improve their capabilities. All smart grid technologies depend on communications; therefore, utilities are faced with a choice: to deploy a dedicated communications network to support future smart grid technologies, or to leverage the existing SmartMeter™ network. If the existing SmartMeter™ network is capable of supporting these new technologies, both the utility and ratepayers might benefit through the potential deferral of costs.

## 4 Project Initiatives: Results, Findings, and Recommendations

EPIC Project 1.14 explores new network strategies and technologies to leverage and improve the SmartMeter™ AMI communications network. The project also focuses on investigating and validating how new applications and devices can leverage this network for customer and utility benefits.

The project was comprised of a number of separate initiatives which can be broadly categorized into three project tracks: *Demonstrating the Capabilities of the SmartMeter™ Network*, *Leveraging the SmartMeter™ Network for Smart Grid Devices and Applications*, and *Enhancing the SmartMeter™ System for Outage Reporting*. The sections below describe the scope, findings, and recommendations for the initiatives within each of the three project tracks.

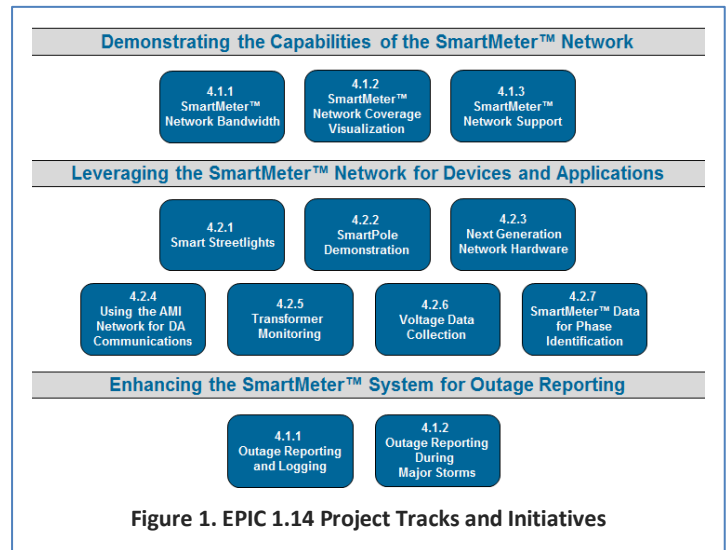

### 4.1 Demonstrating the Capabilities of the SmartMeter™ Network

This project track encompassed initiatives that demonstrate ways in which PG&E might extend the SmartMeter™ Network (SMN) for applications beyond the existing scope. When the SMN was first deployed, there was some concern about using the network for non-metering applications and devices. The primary goal of this EPIC project track was to analyze the available bandwidth and capabilities of the SMN and validate its potential to use for advanced smart grid applications and devices without jeopardizing day-to-day metering operations.

The SMN uses a mesh networking topology. In a mesh network, each node relays data to other nodes (e.g., meters and Relays); and all nodes in the mesh cooperate to move data through the network. The SMN routes a message along a path by “hopping” the message from node to node until the message reaches its destination using a method called Frequency Hopping Spread Spectrum<sup>6</sup> (FHSS). To ensure the integrity of the network, it must allow for continuous connections and must reconfigure itself around broken paths, using self-healing algorithms which allow the network to continue to operate when a node becomes unavailable. As a result, the network is typically quite reliable, because there is often more than one path between a source and its destination on the network.

#### 4.1.1 SmartMeter™ Network Bandwidth

The overall objective of the EPIC 1.14 project was to identify and investigate emerging technologies that could potentially improve or extend the SMN’s operational capabilities. In order to evaluate the impact that these technologies, if scalable, might have on day-to-day customer metering operations, it was necessary to establish a foundational understanding of the current capabilities of the SMN.

<sup>6</sup> A method of transmitting radio signals by rapidly switching between many frequency channels, using a pseudorandom sequence known to both transmitter and receiver.

The major tasks and deliverables of the SmartMeter™ Network Bandwidth initiative were to:

1. Analyze current bandwidth utilization of the production SMN in order to establish a baseline for analysis of future use cases;
2. Characterize current traffic patterns and characteristics;
3. Achieve objectives 1 & 2 via a repeatable methodology that can be used to analyze future use cases.

This initiative utilized a two-fold approach. First, 900MHz wireless mesh lab testing was conducted at PG&E's Smart Grid Communications Lab (SGCL) facility to establish effective utilization thresholds on the SmartMeter™ mesh network. These tests were performed at various routing configurations (hop counts) and with network packet sizes that were representative of normal customer metering payloads. These thresholds were then referenced in analyzing a statistical sample of APs (Access Points, which connect the local mesh to the data center) and meter mesh sub-networks on the SMN, analyzing metrics such as hop count, meter-to-AP loading densities, and round trip message latency.

### **Technical Results and Findings**

The test scenario involved injecting UDP (User Datagram Protocol) traffic of different packet sizes and different throughput rates into the test network, and recording the results up to the point of packet fragmentation. The packet sizes were chosen based on the most common scenarios produced by PG&E's residential meter programs:

- 100 bytes – Amount of data that a SmartMeter™ returns to the back office each read request when reading register data every 4 hours.
- 250 bytes – Amount of data that a SmartMeter™ returns to the back office each read request when reading register (with health flag data) and event data every 4 hours.
- 500 bytes – Amount of data that a SmartMeter™ returns to the back office each read request when reading 1 day worth of register read data from the meter.
- 1200 bytes – To check the network's throughput performance if device is sending large packets (below the IPv6 fragmentation limit) through the network. This scenario is typical of a firmware upgrade, as the packet sizes can be up to 1024 bytes
- 1400 bytes – To check the network's throughput performance if the requested data is over the IPv6 fragmentation limit (1280 bytes).

The following are the results for both uplink and downlink throughput in each of the described packet sizes:

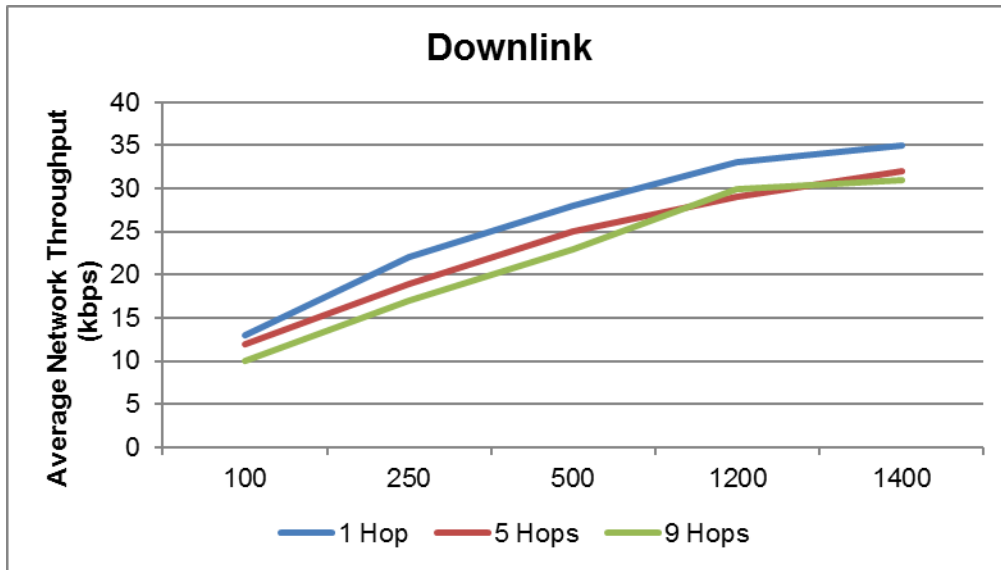

Figure 2. Average Network Throughput (kbps) Downlink

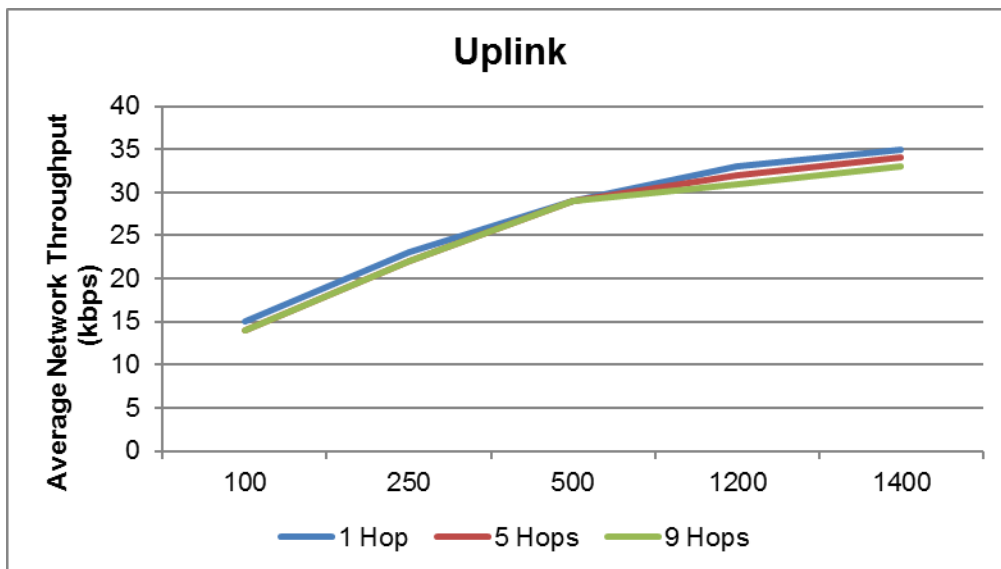

Figure 3. Average Network Throughput (kbps) Uplink

As the above charts show, the number of network hops – from meter-to-meter and from meter-to-AP – has little effect on the network throughput, for all packet sizes. Indeed, the throughput is either the same or gets faster as the number of nodes increases for all packet sizes for both uplink and downlink. This demonstrates one of the advantages of a mesh network – that a greater number of nodes on the network actually strengthens the network rather than weakens it.

The subsequent data analysis from the SMN demonstrated that bandwidth utilization is primarily a direct function of meter-to-AP saturation, and that based on the sample set of APs tested, the current overall network utilization for customer metering operations averages 15-20% of the available bandwidth. During meter read jobs on the most heavily loaded APs, the maximum bandwidth used can reach 50%, however the self-governing nature of the mesh network ensures that high volumes of bursting network traffic can be handled (within reason) with no data loss, and only affect the amount of time required to transmit and receive data. Due to the dynamic nature of the mesh network, the number of meters connecting to any given

AP can fluctuate from day to day, so PG&E evaluated a number of different AP's in a mix of locations with low, medium and high density of meters.

The results from the lab testing conservatively measured the effective usable throughput of the mesh network at 25kbps. Only on the most heavily loaded APs did utilization reach or exceed 25kbps, with no correlating effect observed in read job success rates, only in the length of time taken to complete the read job.

The following charts show the network statistics for an AP with a medium-to-high density of meters (5,971):

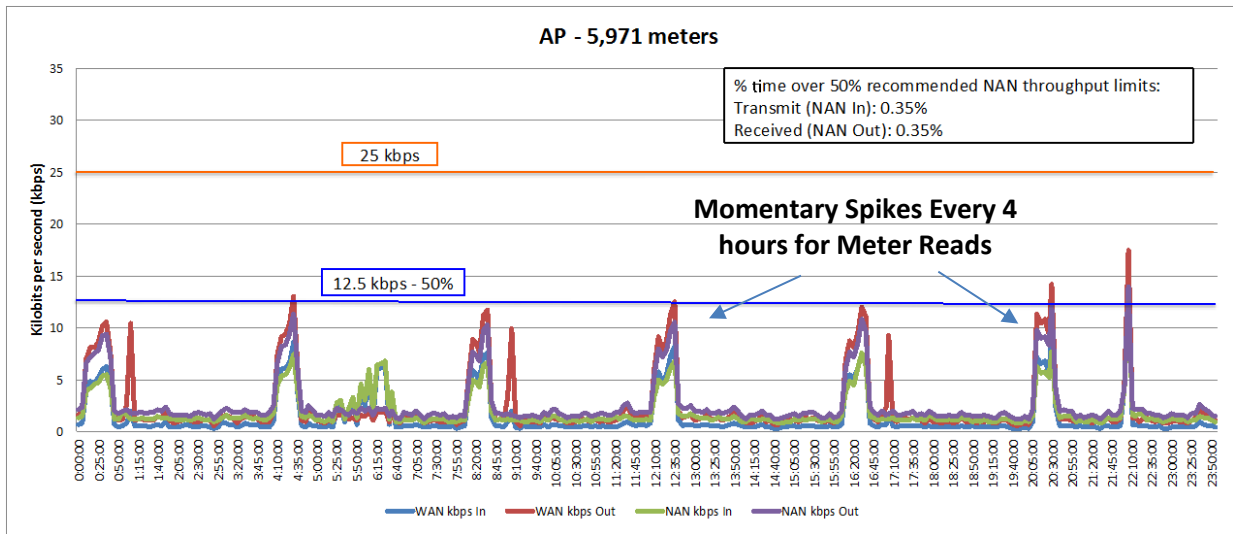

**Figure 4. Network Statistics, Medium Density AP**

In Figure 4 above, the momentary spikes in activity every four hours represent the meter reads. During these meter reads, other data may take longer to reach the AP, but no data loss was observed.

Although PG&E hypothesized that hop count (the number of network nodes a packet needs to pass through to reach the data center) would have an effect on the network, after comparing the results across each individual AP, the data did not validate this hypothesis. In general, four hops seems to be the average, and does not adversely affect the network throughput.

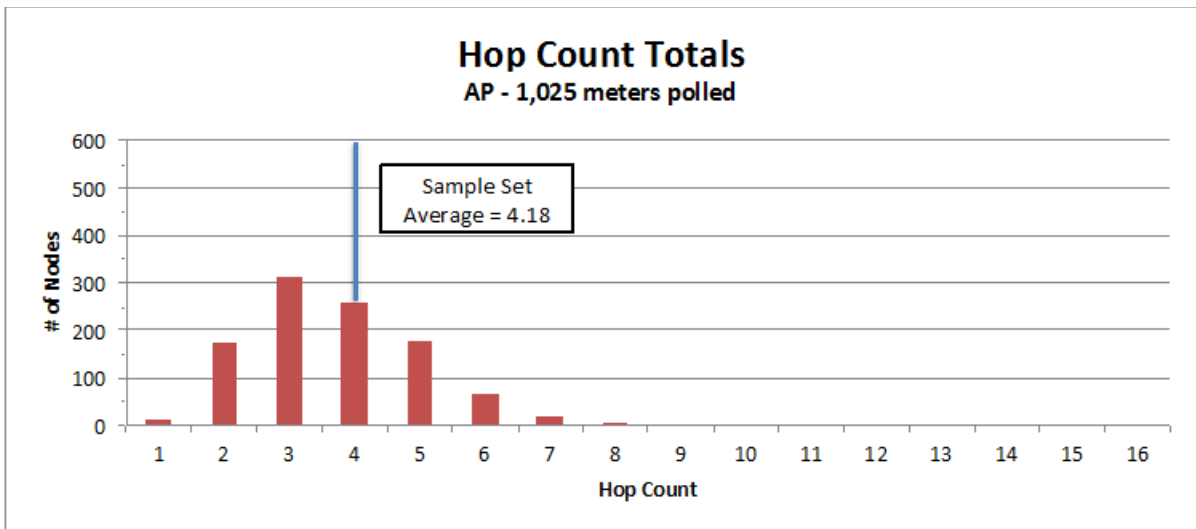

Figure 5. Hop Count Totals, Average

Latency times were generally under five seconds per round trip, which is low enough to warrant investigation for other use cases that may benefit Grid Operations.

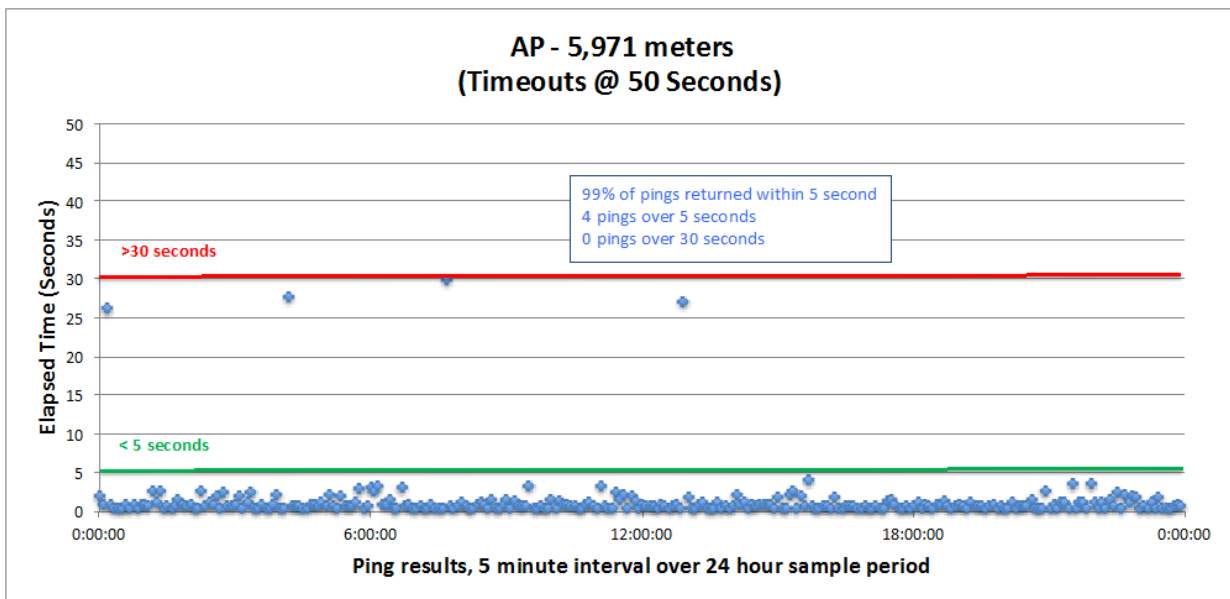

Figure 6. Latency Times, Medium Density AP

**Recommendation**

The baseline analysis showed that during the bulk of its duty cycle on appropriately loaded APs, the SMN has a predictable amount of available bandwidth which PG&E believes is sufficient for exploration into other uses and justifies further investigation. However even with available throughput, **each additional use case** must be analyzed for appropriate fit to ensure that additional devices and applications will not negatively impact the network or create any cyber security risks.

As a result of this successful EPIC demonstration, PG&E now has access to the methodology developed in this initiative when evaluating new applications and devices that leverage the SMN, both in this EPIC 1.14 project and for other projects as well, including the Smart Grid Line Sensors Project.

#### 4.1.2 SmartMeter™ Network Coverage Visualization

This project demonstrated several methods of visualizing the SMN 900MHz radio frequency mesh coverage using *heat maps* (geographical representations of data using colors to indicate different values). The ability to visualize aspects of the SMN could potentially to improve network maintenance and operations.

The major tasks for this EPIC initiative were to determine the difficulty of acquiring the necessary data, and to demonstrate currently-available methods for displaying that data on a map in a manner that might be useful to organizations such as Electric Distribution, SmartMeter™ Operations, and others.

PG&E demonstrated methods of extracting hop count, path cost, and Received Signal Strength Indication (RSSI) values from the SMN’s network monitoring application, as well as a new operational data streaming service in development from PG&E’s network vendor. This data might then be displayed in Google Earth Pro and PG&E’s mapping system to create heat maps.

#### Technical Results and Findings

Within the context of the pilot, PG&E was able to demonstrate several methods of extracting data from the SMN and was able to visualize it on useful maps. While PG&E was able to demonstrate methods of extracting hop count, path cost, and RSSI values from the network application suite, these applications do not currently offer a means to collect this data automatically. A new operational data streaming service that may soon be available to PG&E may allow extraction of this data from the network and may provide an alternative for mesh coverage visualizations.

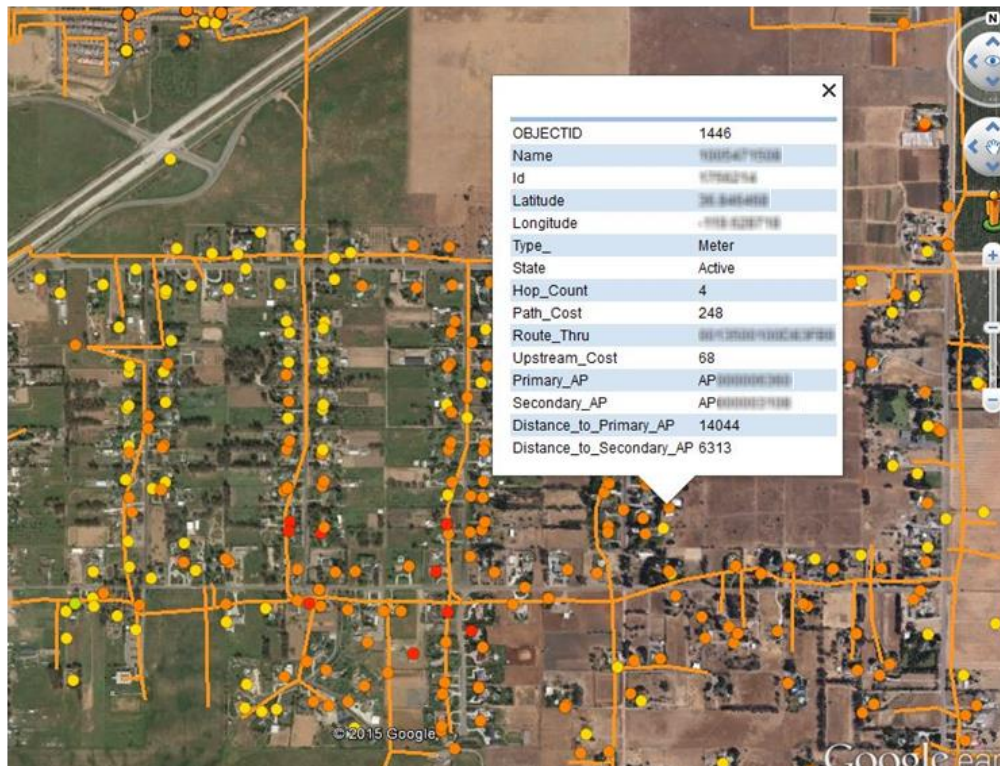

Figure 7. Network Node Visualization

PG&E demonstrated a map visualization of the raw data using Google Earth Pro. PG&E’s Enterprise Asset Management Geographical Information Systems (GIS) team might also be able to create geospatial analytics that can be displayed in the corporate mapping application.

## Recommendations

These visualizations could potentially be tailored to fit various business needs and made available to a wide audience. The ability to visualize aspects of the SmartMeter™ communications network has the potential to improve PG&E's network system reliability.

The new operational data streaming service (released after completion of the initiative) could allow extraction of this data from the network, potentially providing data that can be used for mesh coverage visualizations.

### 4.1.3 SmartMeter™ Network Support for Smart Grid Devices and Applications

This initiative demonstrated the impacts of non-AMI traffic on the SMN, with all traffic routing over IPv6 over the native PG&E SMN. The types of network traffic demonstrated were:

- **Transmission Control Protocol (TCP)** network throughput across the Radio Frequency (RF) mesh network via the Smart Grid Communications Laboratory (SGCL) shield box<sup>7</sup> test harness. TCP is a common network protocol choice for third party application developers.
- The impact of **Solicited Traffic** throughput when transferring large amounts of data across the RF mesh at the same time as scheduled meter read jobs to simulate third party applications polling for data from non-meter devices on the SMN.
- The impact of **Unsolicited Traffic** throughput when pushing unsolicited data from a mesh endpoint to a destination host/location in the data center, such as waveform or other operational metrics being pushed from a device such as a wireless mesh-networked line sensor.
- **Communication with an Intelligent Endpoint Device (IED)** such as a capacitor controller using the DNP3 protocol routed through IPv6 traffic.

All tests were performed in the Smart Grid Communications Lab, using a shield box test harness, a meter farm consisting of 125 SmartMeter™ devices and two APs, and dedicated eBridge networks.

## Technical Results and Findings

While one of the primary functions of the SMN is to transport day-to-day customer metering data, PG&E is interested in future uses of this network to enable Smart Grid devices and technologies. In the previously discussed EPIC 1.14 SmartMeter™ Network Baseline Assessment initiative (section 4.1.1), PG&E tests suggested that existing metering functions use only 15-20% of the available bandwidth on the network. There may be bandwidth to explore using for other purposes. This initiative assessed the potential ability of the SMN to support various networking protocols and loads without jeopardizing day-to-day metering functions.

### *TCP Network Throughput*

Normal metering traffic over the SMN uses User Datagram Protocol (UDP), which is a transport-layer networking protocol. UDP is a message-based connectionless protocol, which means that the sending device does not establish a connection to the receiving device prior to sending a packet, and there is no acknowledgement of receipt when a packet is received.

---

<sup>7</sup> A radio-shielded test setup, used to ensure that the equipment being tested is not affected by ambient radio signals.



Transmission Control Protocol (TCP) is a connection-oriented protocol that requires the two transmitting end points to establish a connection prior to transmitting data. For this reason, TCP generally exhibits lower throughput over the same network, but better message receipt rates. Future uses of PG&E's SMN involving applications developed by third parties are likely to use TCP rather than UDP.

Testing was performed using a range of packet sizes and logical network hops. Due to the overhead associated with connection-oriented protocols such as TCP, the overall throughput for TCP traffic over the RF mesh network was lower than for UDP traffic of the same payload size, as expected. Throughput rates were lower by as much as 50% for a 100-byte payload in a logical 9-hop downlink test, and 28% for a 1400-byte payload in a logical 1-hop downlink test.

#### *Solicited Traffic Throughput*

PG&E's SMN uses several techniques to manage the flow of traffic from the application host to the nodes on the mesh. However, these gating mechanisms do not affect third-party applications that can initiate network traffic that routes through the APs. Although in project tests the solicited traffic introduced on the SmartMeter™ Network did affect the speed of normal network traffic, the test demonstrated that this un-gated traffic did not affect the overall success of normal traffic such as scheduled meter read jobs. The meter read jobs took longer to complete, but were still fully successful in the test network.

#### *Unsolicited Traffic Throughput*

Unsolicited traffic includes large data files that do not originate from a meter or an AMI Network Device such as an AP or a Relay, for example a waveform from a wireless communicating line sensor that uses the SMN's relays to transmit data to distribution engineering. This test showed that transmitting large files upstream from a node can potentially put significant traffic on the network (depending on file size) that is not modulated by the network's current throughput gating mechanisms. For this reason, each use case should be individually assessed prior to implementation. It may also be possible to mitigate the additional traffic by strategically adding network assets (see section 4.2.3).

#### *Intelligent Endpoint Device Control*

PG&E was unable to demonstrate end-to-end connectivity over IPv6 from a SCADA simulator to the Intellicap (capacitor controller) device due to the fact that SCADA implementations have not yet begun to support the DNP3 protocol over an IPv6 network. PG&E's network vendor offers a solution that uses IPv4-based communications for IED support, which is detailed in section 4.2.4 below.

## **Recommendations**

The results of the first three tests demonstrate the ability of the SMN to transmit data not related to day-to-day metering operations. These tests also demonstrate the ability of the network's management applications to modulate traffic related to normal SmartMeter™ operations such as meter read jobs which helps it to transmit the additional traffic while still completing these operations. Based on these results, PG&E will consider pursuing the following strategies:

- Continue developing use cases to leverage the SMN for uses other than its traditional purposes;
- Analyze any new applications for their impact for their impact on the SMN (with methodologies developed in the SmartMeter™ Network Baseline initiative), particularly those that do not use existing traffic gating mechanisms;

- Continue to evaluate the network vendor and third-party vendor products' capabilities to manage network performance as a whole and for each product; and
- For IEDs, proceed with the more traditional Distribution Automation (DA) approach, using IPv4 addressing as opposed to IPv6 addressing. For more information, see section 4.2.4 below.

## 4.2 Leveraging the SmartMeter™ Network for Smart Grid Devices and Applications

Having demonstrated that PG&E's SMN is fully able to support network applications and devices in addition to day-to-day metering traffic, this set of project initiatives was intended to demonstrate various hardware devices and applications in laboratory conditions (and for some initiatives, in a limited fashion, on the production SMN). For these EPIC initiatives, PG&E demonstrated the connectivity proof of concept for the following devices and applications:

- **Smart Streetlights** – a demonstration of streetlight photocells for remote control, monitoring, and billing.
- **SmartPole Demonstration** – a limited demonstration for the City of San Jose to enable low-profile metering for their telecommunications equipment.
- **Next Generation Network Hardware** – a demonstration of newer mesh network hardware, both to confirm that it operates well with existing network hardware, and to see if there may be use cases where it would be beneficial to deploy.
- **Transformer Monitoring Devices** – a demonstration of both a commercially-available product to monitor transformer health, and a very low-cost temperature-sensing IED assembled from off-the-shelf components to demonstrate the possibility of monitoring residential transformers.
- **DA Communications** – a demonstration using Distribution Automation (DA) hardware components to route SCADA traffic over the SMN.
- **Voltage Collection** – a demonstration of various means of collecting voltage data from SmartMeter™ devices and an exploration of practical use cases.
- **Phase Identification** – a demonstration using voltage data recorded by SmartMeter™ devices to help identify which phase of the three-phase power system is connected to a customer's meter.

### 4.2.1 Smart Streetlights

PG&E owns a number of streetlights throughout its service territory. These streetlights are currently equipped with conventional photocells that switch the streetlight on at dusk and off again at dawn. The goal of this initiative was to demonstrate the advantages of installing mesh-network-enabled photocells equipped with Network Interface Cards (NICs) that communicate via PG&E's existing SMN. Some advantages of mesh-networked photocells include the ability to remotely monitor and control streetlights, as well as collect billing-grade metering data from the streetlights.

The overall objective of this initiative was to demonstrate the potential benefits of using mesh-networked photocells to provide maintenance, billing, and control functions for PG&E-owned streetlights. As part of this initiative, PG&E also assessed the impact of the mesh-networked photocells' message traffic on the SMN.

Over four phases of testing, this project demonstrated control, maintenance, and metering functions of several SMN-compatible photocell devices, with both high-pressure sodium and newer LED streetlights.

### Technical Results and Findings

Smart Streetlights require a photocell that has been integrated with a Network Interface Card (NIC) that is

compatible with PG&E’s SMN. These photocells are currently available from several vendors. As part of this demonstration project, PG&E tested 22 mesh-networked photocells from three different vendors in the Smart Grid Communications Laboratory (SGCL), the demonstration test yard at PG&E’s Advanced Technology Services (ATS) facility, and in the field on the production SMN.

In addition to basic adaptive controls like the ability to monitor lights, turn lights on and off, dim lights, and send alerts when a streetlight fails, this initiative demonstrated that mesh-networked photocells have the potential to extend and strengthen the SMN; they also provide outage data in the same way as meters. For billing purposes, mesh-networked photocells provide highly accurate kWh measurement that meets PG&E’s billing accuracy requirements. Further, their ability to interoperate across the SMN unlocks the potential to enable and connect Smart City devices.

The results from all areas of testing – interoperability, monitoring & control, network capacity, and hardware evaluation – show that the mesh-networked photocells function as designed and can be integrated into the SMN. The photocell hardware was demonstrated to function properly in a range of temperature conditions and worked with high pressure sodium as well as newer, more energy efficient LED lights. For billing purposes, they provide highly accurate kWh measurement that meet PG&E’s billing accuracy requirements.

In laboratory tests, PG&E demonstrated that mesh-networked photocells function on the SMN in the same manner as a meter. They found that all network commands (e.g., ping, trace route, on-demand read, alarms and events) can be performed or viewed for the photocells. They use a similar NIC and have a similar throughput:

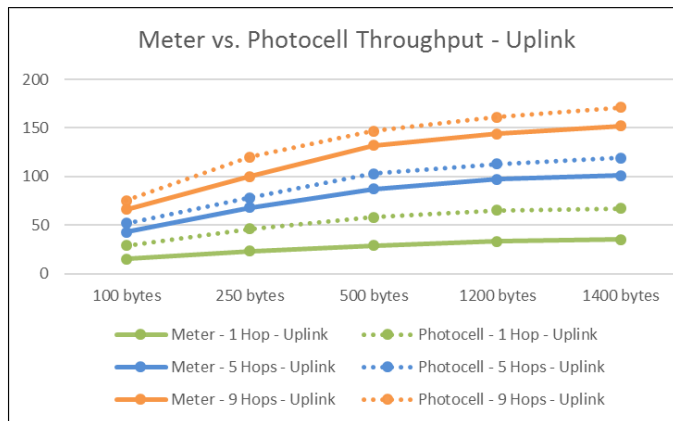

Figure 3. Average Network Throughput (kbps) Comparison – Uplink

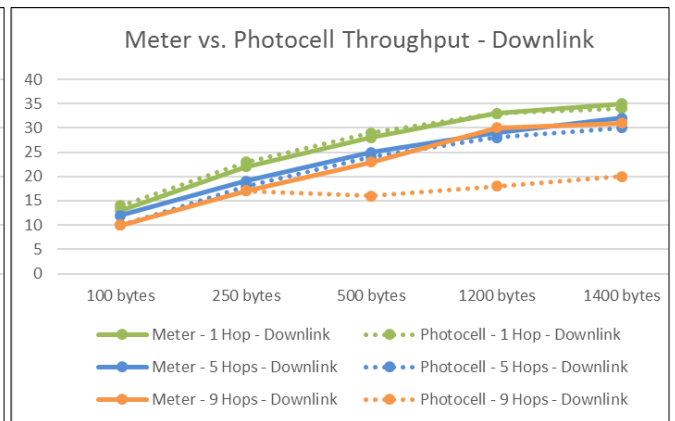

Figure 2. Average Network Throughput (kbps) Comparison – Downlink

**Recommendation**

The 22 photocells tested integrated easily into the SMN with no negative impacts to the existing mesh network, and by adding more nodes that are elevated and therefore can “see” more meters, they have the potential to strengthen and enhance the SMN. This could be a particular advantage in areas where there is a sparse meter population. PG&E is considering the possibility of incorporating these photocells into the current LED streetlight replacement project.

**4.2.2 SmartPole Demonstration Project**

Presently, PG&E sometimes has to estimate the energy usage of civic and corporate telecommunications customer equipment installed or mounted in space-constrained locations – for example, telecommunications

equipment and holiday lighting mounted on streetlights – and bill the customer at a flat rate, or sometimes not at all. These methods do not reflect their true energy usage. In the past, the only metering solution that PG&E was able to offer these customers was a standalone metering pedestal that is typically installed next to any equipment using metered electricity. This metering solution is bulky, unattractive, and not cost-effective.

In a separate project, PG&E’s Metering Services and Engineering group had developed a next-generation pole-mounted meter at the request of the City of San Jose and a vendor for a SmartPole (a streetlight that also houses 4G/LTE cellular telecommunications equipment) that has the potential to leverage and improve upon PG&E’s existing SmartMeter™ Network. The demonstration phase of this initiative was incorporated into this EPIC 1.14 project.

The next-generation meter tested in this initiative is a new low-profile meter

installed on top of a SmartPole that blends seamlessly into its environment. Eliminating a standalone meter pedestal can help to de-clutter dense urban areas and increase safety by locating meters and their associated electrical conductors high above street level. This meter provides a versatile, low-cost metering solution with a small footprint that can be leveraged for residential, commercial, and mobile applications.

This meter gives PG&E the ability to meter loads for telecom equipment mounted on streetlights and power poles in confined spaces that reflect their actual energy usage. This can eliminate the current practice of billing these loads at a flat rate or not at all. This small footprint meter can be installed and mounted on top of a pole and can help both PG&E and its customers capture savings by eliminating a standalone meter pedestal installation and its associated labor costs (up to \$1,000 per pole). Also, this new metering solution can give PG&E the ability to monitor and control loads for future applications such as smart inverters and electric vehicle charging stations in support of PG&E’s Smart Grid initiative.

The major tasks and deliverables for this initiative included:

- Install new metering devices in 50 locations in San Jose, in conjunction with the City of San Jose and a vendor.



**Figure 4. Traditional Pedestal and Pole Mount Meters**



**Figure 5. SmartPole Meter (Identified With Red Arrow)**

- Demonstrate the ability to accurately measure kWh usage and accurately bill the customer without adversely affecting the current billing system.

### **Technical Results and Findings**

This small-footprint meter is based on the same metering technology and NIC demonstrated in the Smart Streetlights initiative discussed in section 4.2.1 above. The network and metering test results for the mesh-networked photocells therefore also apply to these devices. Additional technical specifications including dimensions and installation options are available in Appendix A – Technical Specification Sheet for the GoT™ SmartPole Meter.

A total of 50 SmartPole meters have been installed in the field in a demonstration program for PG&E, the City of San Jose, and a vendor. These meters have been communicating with PG&E’s production SMN as expected, and energy usage data has been sent and received by PG&E’s billing department. PG&E has been able to process the received data and has issued electric bills to the SmartPole vendor since the demonstration project began in September 2015.

SmartPole meters have passed the project’s tests for safety, reliability, and accuracy requirements. They have shown compatibility with PG&E’s existing SMN by automatically synching and communicating with the network when installed in the field. Also, in a similar manner as Smart Streetlights, these devices could expand and strengthen the SMN, because they are elevated and can transmit more clearly than ground level devices. Similar to SmartMeter™ devices, they can be programmed remotely and transmit their interval energy (kWh) usage every 4 hours. Billing operations testing was also demonstrated and proven to work, thus leveraging PG&E’s existing Meter Data Management System (MDMS) and Customer Care and Billing (CC&B) systems.

### **Recommendation**

This new small-footprint meter has the potential, if scalable, to support metering loads and monitoring new smart grid applications such as electric vehicle charging stations and smart inverters. PG&E could coordinate with internal stakeholders to develop processes and training material to assist in exploring deployment of this new meter.

#### *4.2.3 Next Generation Network Hardware*

The primary component of the SMN is the collection of network devices used in SmartMeter™ devices, Relays, and Access Points (APs). PG&E’s networking vendor has released a newer generation of network devices, their fourth generation technology. These devices offer newer features that may be beneficial on PG&E’s SMN. Older generation devices are no longer available for purchase, although PG&E still has inventory of older generation devices that have not yet been deployed. The goal of this initiative was to demonstrate the potential benefits and use cases for this new hardware, and to determine if there are situations where deploying next generation network hardware would provide a compelling cost advantage.

This newer generation networking equipment features devices that include faster throughput (from a theoretical upper limit of 100kbps to 300kbps) and “gear shifting” technology that allows the device to change speeds (down to 50kbps), allowing backward compatibility with older devices.

PG&E’s current SMN consists of earlier 100kbps second- and third-generation devices. In the EPIC 1.14 SmartMeter™ Network Baseline Assessment initiative (discussed in section 4.1.1 above), PG&E demonstrated that the backhaul network is not a network constraint, therefore this initiative focuses only on the device-to-device network bandwidth capabilities of fourth-generation devices (i.e., meters, Relays, and APs) using tests

conducted at PG&E's Smart Grid Communications Laboratory (SGCL). In terms of cyber security, next generation devices use the same strong Public Key Infrastructure (PKI) based encryption standard used in the previous generation devices. PG&E has previously performed extensive tests of this PKI encryption.

The project plan included the following major tasks and deliverables:

- Lab testing, using the same testing environment and methodologies used in the SmartMeter™ Network Baseline initiative, to assess the actual throughput of fourth-generation devices in an entirely fourth-generation environment and to compare these results with the older generation devices tested in the SmartMeter™ Network Baseline Assessment initiative. PG&E also tested these devices in a mixed environment of fourth-generation and older devices to verify that they communicate well and can “gear shift” to ensure backward compatibility.
- Discuss with other utilities using devices from the same vendor to find out how they are deploying and using fourth-generation devices, and what their experiences have been so far.
- Recommend use cases where fourth-generation equipment may be beneficial or provide a more cost-effective solution than the devices currently deployed in PG&E's SMN.

### **Technical Results and Findings**

PG&E demonstrated that the fourth-generation devices function as expected, both in an entirely fourth-generation environment and in a mixed environment with older generation devices. In 1-hop tests, the throughput was up to five times the throughput that was seen in the older devices tested in the SmartMeter™ Network Baseline Assessment initiative (see section 4.1.1). The “gear shifting” technology that allows fourth-generation devices to communicate with older generation hardware worked as expected, and did not require any special configuration or adjustments. PG&E's discussions with other utilities that have already deployed these devices in the field indicate that this is consistent with their observations. None of the utilities PG&E spoke with are running an entirely fourth-generation network.

While PG&E had expected that the existing test harness would be sufficient to ramp down speeds below 100kbps, the devices performed better than expected at the 100kbps range, and the test harness was unable to force the devices to ramp down further. The devices continued to communicate successfully at 100kbps through the extreme capabilities of the test harness. Even with the introduction of -50dB of interference, the throughput did not drop below 100kbps.

### **Recommendations**

As a result of this successful EPIC demonstration, PG&E has the confidence going forward to explore full certification of these fourth generation devices. PG&E's network vendor has recently stopped selling pre-fourth generation devices, and full certification should be completed before PG&E depletes its current inventory of pre-fourth generation network devices.

While PG&E does not recommend a wholesale replacement of older devices, as this would be cost prohibitive, this project did identify certain use cases where it may be beneficial to employ an entirely fourth generation environment, including heavily loaded APs, and situations where larger data files may need to be transmitted on a regular basis (see section 4.1.3) without impacting the network. PG&E may also attempt to remain updated on new developments in the product arena, including evaluating the vendor's forthcoming fifth-generation network hardware, which promises throughput up to 1Mbps.

#### 4.2.4 Using the SmartMeter™ Network for Distribution Automation Communications

This project initiative demonstrated the capabilities of a Distribution Automation (DA) solution set compatible with the SMN that includes Master & Remote eBridges, Relays, and network device management and monitoring software. These components were integrated with PG&E's standard SCADA software and a subset of supported Remote Terminal Unit (RTU) devices (e.g., Capacitor Bank Controllers, Line Regulators, etc.).

This project consisted of three phases:

- Lab testing: connectivity – Initial testing done in the Smart Grid Communications Lab (SGCL) in order to understand the solution set and how it interacts with the PG&E environment and to ensure that the communication devices (eBridges) pass cyber security review.
- Lab testing: SCADA – This phase of testing was focused on polling and controlling physical grid distribution automation with RT SCADA.
- Limited Field Demonstration – This final phase of testing involved controlling a small number of distribution reclosers using DA radios for communications.

From a networking perspective, there are two options when deploying this architecture, *separate* or *converged*.

- *Separate* utilizes a completely different set of Relays than the SMN, building a parallel network optimized specifically for DA traffic. It also requires a separate set of Access Points to perform device management via the controller application.
- *Converged*, or mixed AMI/DA leverages the same network Relays as the SMN uses, but does not use the SMN's Access Points because the traffic is local, and does not affect metering operations. The base SMN Relay network can be strategically extended with additional Relays to provide more routes for DA if necessary. This deployment leverages the investment made in the mesh network infrastructure, and is the architecture used in this EPIC demonstration.

Discussions with other utilities revealed that converged deployments are preferred over separate, and at least one of the utilities using a separate network today is now strategizing on how to converge with their AMI deployment.

#### Technical Results and Findings

The testing in the SGCL ran between a workstation, Master and Remote Bridges, and a Relay for initial communications tests. On this test network, PG&E used a local copy of RT SCADA to control a capacitor bank controller (not connected to a capacitor bank). The communication devices passed internal cyber security review.

Two connectivity tests were performed to verify communication paths worked as expected. The first was intended to route packets from the Master eBridge through two generations of Relays, and on to the Remote eBridge. This traffic is representative of IPv4 SCADA polling and control traffic as shown by the red solid line in Figure 12.

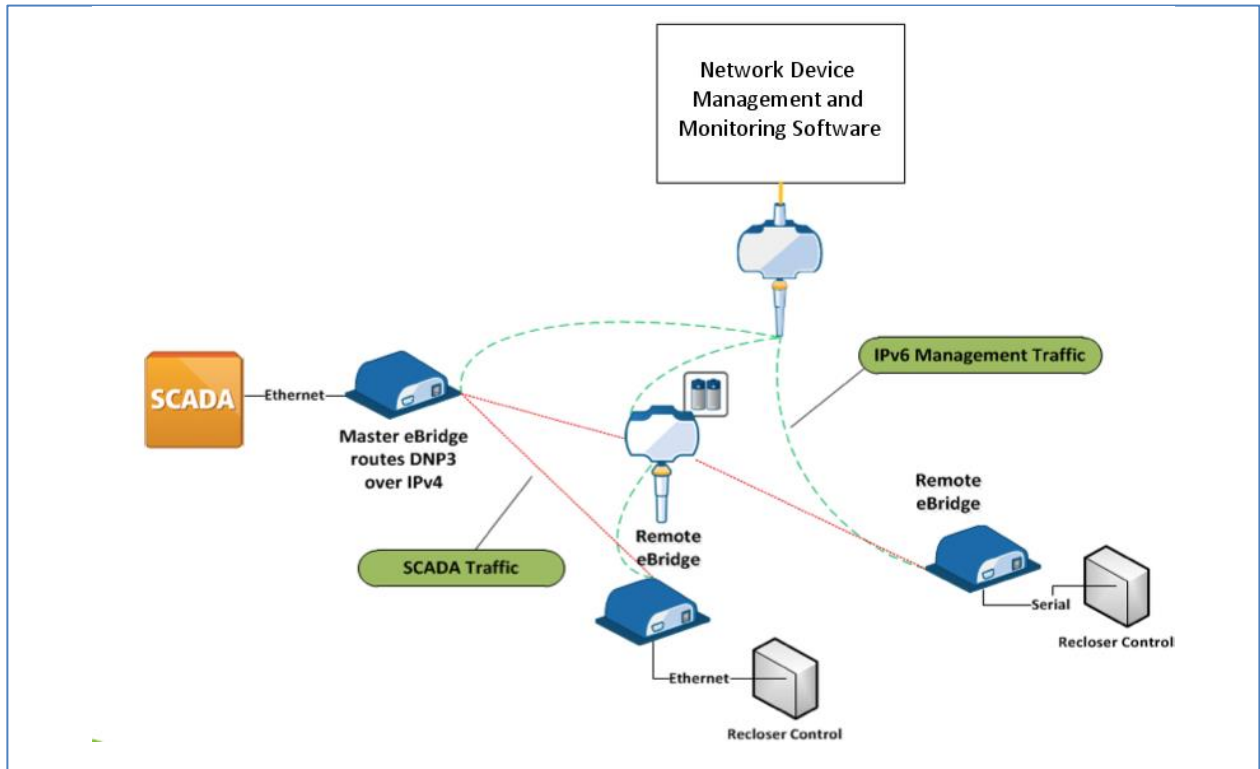
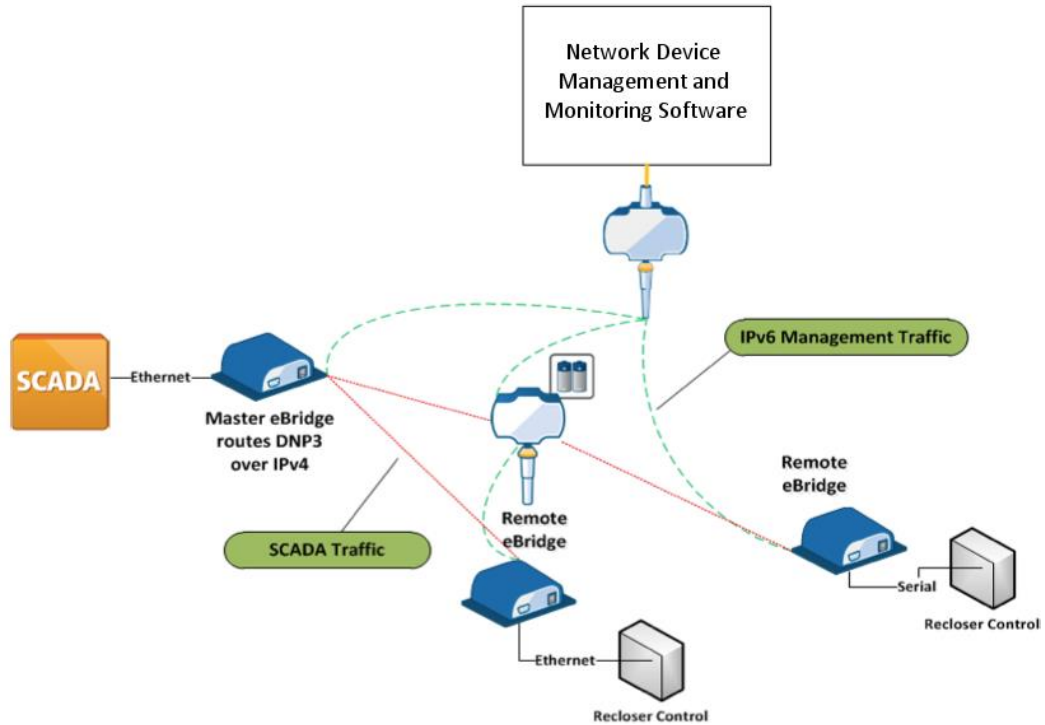

**Figure 12. DA Communications Test Setup**

The second connectivity test involved transmitting IPv6 traffic from the AMI head end host to the Remote Bridge via an AP. This traffic is representative of the application’s device management traffic as shown by the dotted green line in Figure 12.



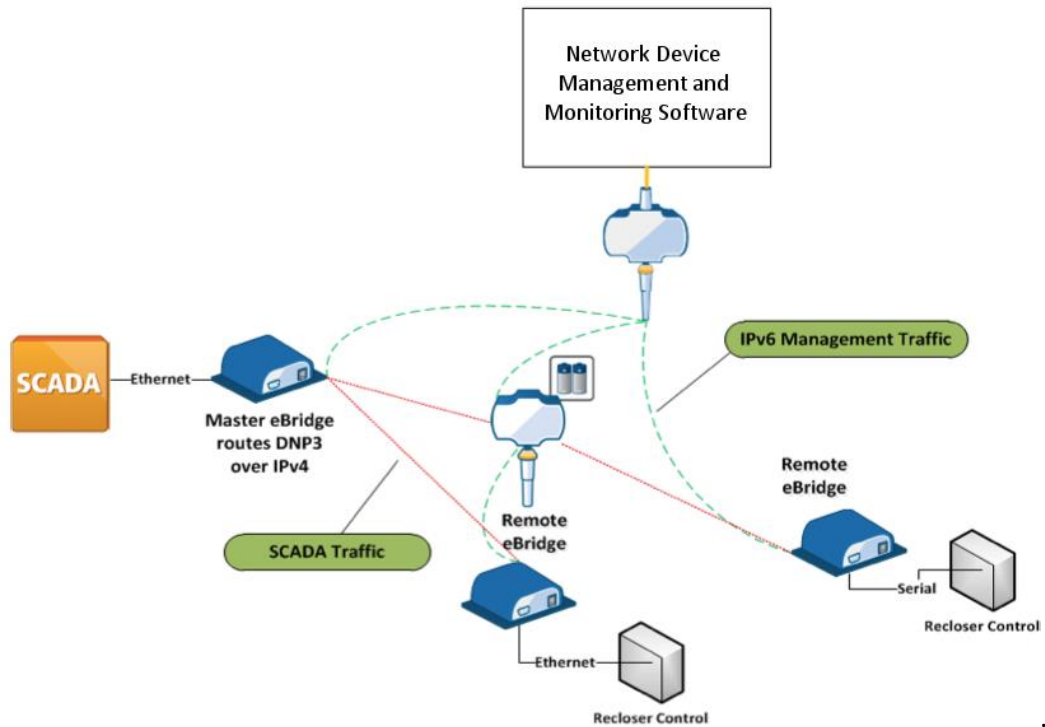

Both communications tests were successful.

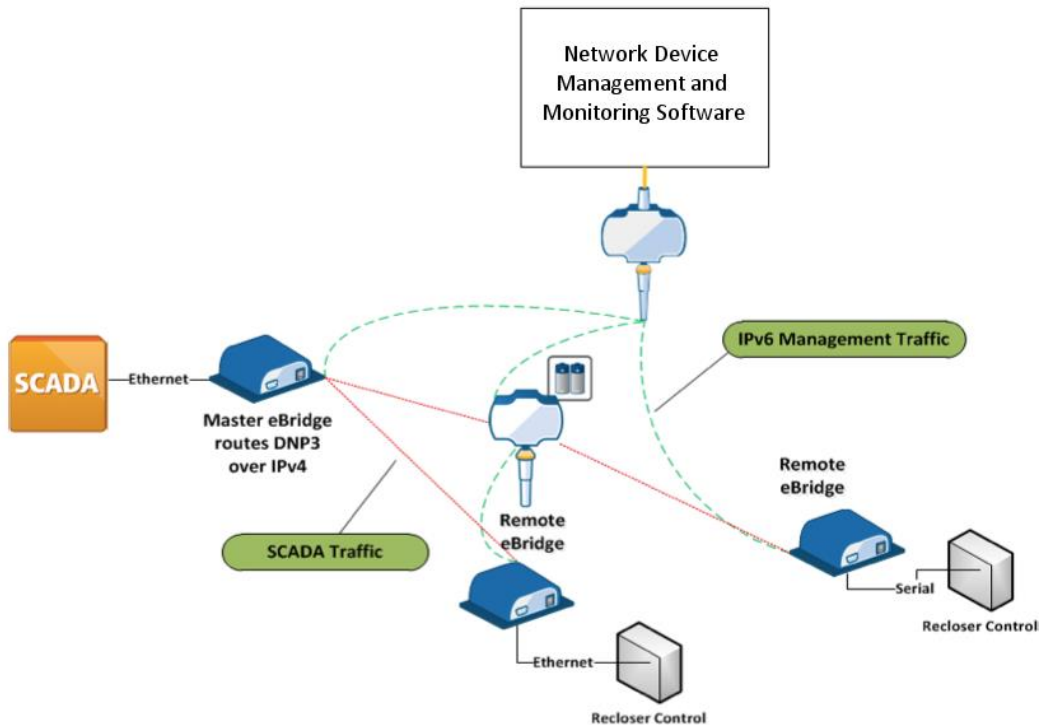

The next laboratory test demonstrated telemetry and control of two PG&E standard distribution devices using standard RT/SCADA templates provided by the SCADA specialist support team. A failover test was performed, this time looking at the result in RT/SCADA. The system recovered flawlessly. Finally, PG&E tested security protocols in the laboratory and found that there was no disruption in communications with security protocols enabled.

Based on successful lab and SCADA testing, the decision was made to attempt a small field test, with the objective of demonstrating SSN DA communications performance at distances. The test indicated that the equipment can support PGE2179 protocol routing through PG&E's converged AMI mesh network over distance, and with sufficiently low latency to enable the end devices to pass entrance criteria to be released for use in SCADA. This was achieved with no discernable impact on day-to-day metering operations.

### **Recommendations**

This option gives PG&E the potential opportunity to replace existing low elevation cellular modems which have a per-month, per-radio cost, and reduce congestion on the existing 900MHz SCADA radio platform. This successful EPIC demonstration has given PG&E the confidence to consider a larger and more comprehensive demonstration to determine the best fit for this solution in the overall portfolio of SCADA communications. PG&E has shared these findings with other IOUs that use the same networking technology.

#### *4.2.5 Transformer Monitoring*

There are many benefits to lower-cost transformer monitoring. The plug-and-play nature of the Electric SmartMeter™ mesh network gives PG&E the potential to significantly reduce the communications engineering requirements for these applications, and the price point for devices already on the market is low compared to traditional substation transformer monitoring implementations. This opens up the possibility for deployment to small substations, field autotransformers, and large customer transformers that otherwise would not be cost-justified.

The EPIC 1.14 Transformer Monitoring initiative was intended to demonstrate methods of monitoring transformers using the SMN. Adding transformer monitors to the SMN also has the potential to improve network performance by providing additional nodes on the mesh network. A networked device located at a pad-mount or pole-mount transformer would have better RF range than most meters, so it would likely reduce the average number of network hops in that area.

The major tasks for this project included an industry review, gathering possible use cases representing business value, and demonstrating transformer monitoring applications and devices on the SMN. This demonstration did not include commercial and technical selection of a specific vendor, or accuracy certification in the lab, and should not be considered as a replacement for Standards work and the thorough end-to-end testing required prior to deploying new technology into the PG&E environment.

PG&E tested a commercial smart grid transformer monitor intended for medium-size transformers that would not be cost-effective to monitor using conventional technology. PG&E had hoped to find a commercial product intended to monitor smaller residential transformers, but found that there were currently no such products available in the market. PG&E therefore decided, as a proof-of-concept, to develop, assemble, and demonstrate a low-cost test device that used off-the-shelf components to monitor transformer temperature. While there are many things that can indicate the health of a transformer, abnormal temperature readings are generally among the predictors of transformer failure.

### **Technical Results and Findings**

PG&E demonstrated that transformer monitoring via the SMN is possible today at a cost of a few thousand dollars per device. This is below conventional approaches to substation SCADA transformer monitoring and therefore should enable the justification to monitor smaller, less critical transformers. PG&E has hundreds of transformers that fall into the unit substation, auto transformer and major customer target for this type of monitoring.

The commercially-available transformer monitor demonstrated in this project is compatible with, and communicated reliably through the SMN. All available data could be transported via the network and communications were reliable.

Transformer monitoring could be expanded to even smaller residential transformers if the cost of monitoring could be reduced even further. The SMN makes this technically possible since there are very low-cost communication devices available that can utilize this network.

PG&E developed and demonstrated one of these, using an off-the-shelf programmable communicating temperature (PCT) device that communicates to the mesh network using home area networking (HAN) technology and an open source radio frequency communication device. However, the current HAN implementation does not provide a complete tool set or an established user application to monitor transformers; therefore, further development would be needed both for final hardware and for application support.

### **Recommendations**

It may be valuable for PG&E stakeholder departments, including Distribution substations, Distribution Operations, and Distribution Planning to become familiar with the potentials and capabilities of mesh network-enabled transformer monitoring and formulate business cases for the introduction of these products. Armed with these business cases, PG&E could work with vendors in this small, emerging market to have existing products integrated into PG&E's design standards and, if justified, develop new, lower cost products for wider utility use.

#### *4.2.6 SmartMeter™ Voltage Data Collection*

The meters on the SmartMeter™ Network have the ability to capture voltage readings. At the time of this initiative, only a single midnight voltage reading is collected from all of the 5.3 million meters in operation, which has limited usefulness. Several projects in Electric Distribution and Customer Care have been collecting more granular voltage data (e.g., Volt/VAR Optimization, Load Disaggregation) in small samples. But to support advanced analytics, a system-wide methodology would need to be developed for voltage data collection.

This initiative focused on analyzing various methods of collecting and extracting voltage data from the SmartMeter™ system, and recommending methods for various use cases.

The overall objectives of the SmartMeter™ Voltage Data Collection initiative were to:

- Collect and categorize use cases for SmartMeter™ voltage data collection.
- Identify and demonstrate different techniques of voltage data collection.
- Assess network, storage, and integration impacts of voltage data collection as best possible.
- Propose recommendations for voltage data collection techniques that might support various use cases.

PG&E collected feedback from members of its Emerging Technologies, Distribution Planning, SmartMeter™ Operations Center (SMOC), and IT Enterprise Information Architecture for immediate and future business needs for voltage data. PG&E then grouped the responses by similar attributes such as granularity and immediacy of the data requirements, as well as operational versus analytical focus.

PG&E then assessed the various methods of voltage data collection from meters and the extraction methods needed to make the data available to downstream systems. PG&E assessed these methods using various tools

and scripts in order to gather physical measurements where possible, such as network traffic and data storage impacts. The result was a recommendation for voltage data collection and extraction methods for each of the use cases, noting potential preconditions for sustainable system-wide voltage collection. The voltage collection matrix developed for this initiative is currently being used as the basis for a voltage roadmap project and is a foundational input to the evolution of PG&E's voltage collection strategy.

There are three methods available to collect voltage data from meters in the SMN:

- **On Demand Read.** This method can be used on all production meters, and can be used on individual meters on a scheduled basis.
- **Meter NIC Program.** This method enables a voltage measurement to be collected at the end of each interval, and retrieved every four hours along with usage data. It requires over-the-air reprogramming of the meter's NIC.
- **The network vendor's voltage monitor application.** This method, part of their network suite of applications, was designed to perform high frequency voltage readings to determine if voltage sagged or swelled. The version tested provides the ability to collect high frequency instantaneous voltage data from meters. However, the precision level of such readings can be limited to the integer or one decimal point.

### Technical Results and Findings

PG&E assessed the available methods and determined which might be most appropriate for various use cases.

#### *On Demand Read*

Individual on-demand voltage reads result in little network or storage impact, as the volume is very low. These reads can be done through the network's user interface or from a future mobile field application using network web services via a secure VPN connection to the PG&E User Data Network (UDN). These reads have very little impact on the SMN.

However, current smart grid projects such as the Smart Grid Volt/VAR Optimization (VVO) project, which uses the network Scheduled On-Demand Reads, can create an impact on the network due to the volume of meters involved in these reads on a single distribution feeder. Data would need to be exported via Structured Query Language (SQL) database extracts to be made available to downstream systems. Specific use cases for this type of sampling include customer complaints and suspected downed wire events.

#### *Meter NIC Program*

When the meter NIC is reprogrammed to include an instantaneous voltage reading with every usage interval, network utilization patterns remain constant (i.e., peaks of throughput utilization every 4 hours) with only slightly more data being transmitted in each read. Reprogramming the entire population of meter NICs could have a potentially large impact on the network and would need to be assessed in detail. Data extraction would also need to be made using SQL queries. Specific use cases for this type of sampling include investigating energy theft, phase mapping, and voltage unbalance monitoring. Additionally, with a firmware update to the NIC, this functionality could potentially support leveraging meter voltage to detect wire-down events.

#### *Voltage Monitor Application*

The voltage monitoring application from PG&E's network vendor is a required component of the

mentioned VVO smart grid project. It could be very useful for use cases requiring short-term, high-frequency voltage collection, such as fault investigation.

In addition, this product was also evaluated as an option to measure power quality. Because the sag/swell notification and polyphase meter support aspects of this application were being tested as part of the Smart Grid VVO project, PG&E chose to focus on the instantaneous voltage read capabilities of this product. The instantaneous voltage read is configured in the same way as the sag/swell notification, and is read from the meter at the same time

In the tests of this application with the type of meter that is most predominant in PG&E’s SMN, the project found that voltage reads at periodic intervals of less than 60 seconds were unreliable and are not supported by the network vendor for this type of meter. The voltage reads were quite accurate, but were limited to the recording capabilities of the meter manufacturer, which is in most cases one decivolt, which is rounded up or down. In the network impact tests, it was demonstrated that the high frequency voltage data collection can generate considerably more data traffic than the scheduled meter read job.

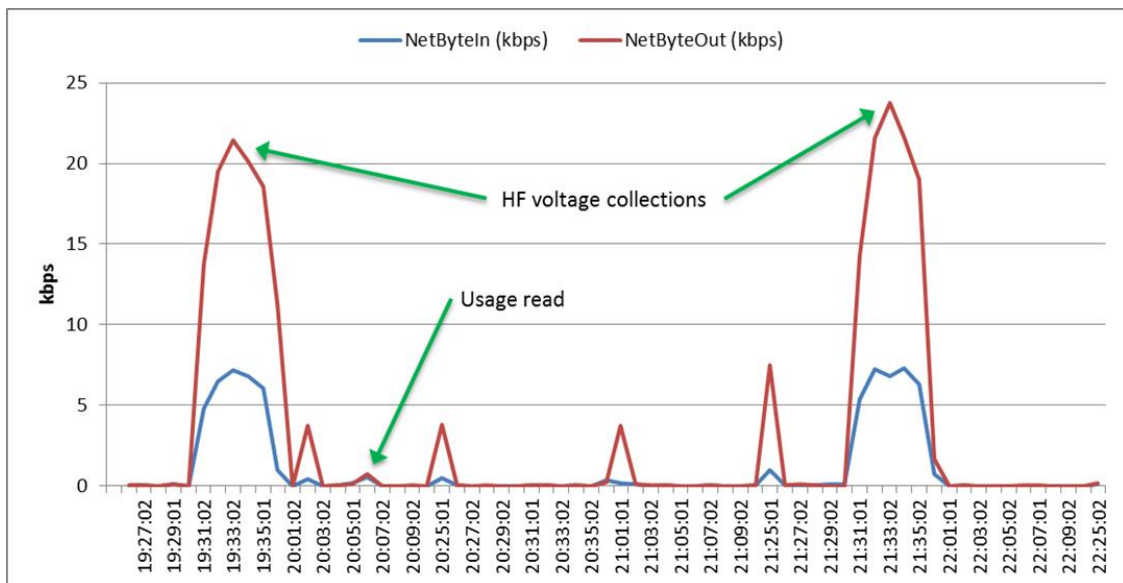

**Figure 13. High Frequency Voltage Collection Network Impact**

PG&E determined that the network vendor’s voltage monitoring application offers a fairly limited focus, with only two capabilities: sag/swell alerting and high frequency voltage collection. The high frequency voltage collection is not supported for intervals of less than 60 seconds on the predominant type of meter, which comprises about half of PG&E’s Electric SmartMeter™ population. Voltage readings are accurate, but are limited to one decimal place. The network impact for data collection is not insignificant.

During the time of this initiative, PG&E’s network vendor announced that they plan to replace this application with a newer product with additional features, which is part of a subscription service with a per-meter cost structure.

**Recommendations**

PG&E demonstrated that reprogramming the meter NICs to include voltage reads on a per-interval basis offers the largest benefit spanning the entire meter population with the least impact to network traffic and at the lowest cost. This can be implemented by enabling a voltage data channel on all PG&E’s meters via NIC reprogramming. To date, about one million of PG&E’s total five million meters have been reprogrammed.

PG&E also recommended working closely with the SMOC and the Interval Data Analytics (IDA) team to add the voltage data collected by the NIC reprogramming to the Teradata system that currently holds usage data. This work has already begun and could enhance the value of the SmartMeter™ data accessible to other operational and analytics systems.

Programmatic requests for on-demand voltage reads via web services and limited use of Scheduled On-Demand Reads satisfy several of the more temporary, targeted operational use cases such as investigating faults, focusing in on distributed generation issues, etc.

	Frequency Extracted	Frequency Uploaded	Installation	Network Impact	Accuracy	Cost	Meters Available (2016)
On Demand	On Demand / Schedule	Real Time	N/A	High for large volume	Integer (Res), 1 Decimal Pt. (C&I)*	N/A	All
Meter NIC reprogram	15 minute (C&I) or 1 hour (R) increments	Every 4 hours	Over-the-air Reprogramming of NIC	Low	Integer (Res), 1 Decimal Pt. (C&I)*	Medium	1 Million (VVO)
Voltage Monitoring Application	High	Adjustable via the head-end	New software + over-the-air profile upload	Low	3 Decimal Point	High (per meter cost structure)	Variable
*Metrology is capable of finer granularity, but current software implementation restricts to integer or single decimal. Certain meter types may report full decimal values depending on the mode they are running in.							

**Table 4-1. Voltage Monitoring Comparison**

PG&E’s recommendation is to continue using the sag/swell alerting capabilities of the current version of the network voltage monitoring application as part of the Volt/VAR Optimization (VVO) smart grid project. PG&E also recommended evaluating the capabilities of the update to this product and to either defer any high frequency voltage sampling until it is released or use the current management product’s web services for small volume, short interval, instantaneous voltage reads. As of August 2016, an evaluation of the new product is underway.

**4.2.7 SmartMeter™ Data for Phase Identification**

A potential capability of using voltage data from PG&E’s AMI is determining which phase of the three phase power system a customer is connected to (A, B, C, or a combination of 2 or 3 of these phases) using voltage data from PG&E’s SMN. This initiative provided a demonstration of two methods of deducing customer phase using data from existing meters in PG&E’s SMN.

Power is distributed most efficiently when the three phases are in balance. Varying customer demands can throw the phases out of balance, which increases line losses and can cause one or more of the phases to provide less than optimum voltage. Engineers attempt to predict power usage by phase and keep the system operating in balance. However, in many locations, the phase that a given home is connected to was never recorded when the home was built. Also, the phase may have been changed over the years, as the system has been repaired and maintained.

Knowing the phase that a customer is connected to is becoming increasingly important because customer demands are changing. Electric vehicles, solar panels, and the increasing proliferation of electronics and smart appliances are changing the way customers are using power, and these changes can potentially result in an unbalanced system. By identifying the phase that each customer is connected to, the load can be evenly rebalanced between the phases.

There are manual techniques for identifying customer phase. However, these methods are expensive, labor-intensive, and need to be repeated on a regular basis to capture changes across the system, and so they have not been widely adopted. One of the potential advantages of a large SmartMeter™ deployment throughout PG&E's service territory is the potential to determine customer phase using data from the SMN in a more cost-effective manner.

This project was a proof-of-concept step toward establishing accurate connectivity mapping from the local distribution substation all the way to the customer's meter. If this mapping can be achieved in a practical and cost-effective manner, SmartMeter™ outage and planning applications might benefit from having more accurate data; safety might be improved through better outage management; and power quality and reliability may also be improved by better system balancing, avoiding voltage excursions and phase overloads. This initiative represented a first step to determine if there is a relatively simple way to identify the customer's phase using SmartMeter™ data that is already available<sup>8</sup>.

The phases of this project included a review of the specific benefits that can be gained by having an accurate connectivity map, an assessment of current industry practices, a discussion of vendor approaches, selection of an approach to study, a simple demonstration of this approach, and a recommendation for next steps.

### Technical Results and Findings

PG&E, working in conjunction with a vendor, identified a test area where the circuits would allow regulation of individual phases to predominantly single-phase residential customers to demonstrate two methods of phase identification:

- In the first method, the voltage was manually raised slightly on each phase (A, B, and C) individually in turn, and the meter voltage data from the SMN was analyzed to determine the most likely phase that each customer meter was on. This method can only be used in locations where it is possible to manually regulate individual phases from the substation.
- In the second method, the meter voltage data was analyzed over the same time period, using an algorithm that iteratively tests phase connections to determine the closest match between the calculated voltage for that location based on its distance from the feeder and the actual recorded voltage from the meter.

---

<sup>8</sup> The *EPIC 2.14 Automatically Map Phasing Information* Project will study this subject in greater detail, and attempt to demonstrate the capabilities of using pre-commercial analytics and/or hardware options to attempt to automatically map 3-phase electrical power.

Both methods resulted in a high level of accuracy – 97.4%-100% – for single-phase tap meters (connected to the lateral) that are connected phase-to-neutral. However, when the meter is connected phase-to-phase (A-B, B-C, C-A), the identification becomes more difficult, as this type of connection was not accounted for in the algorithm used in this initiative. For non-tap meters (meters connected to the main line), the results were only slightly better than random. However, the results do suggest a high rate of accuracy could be achieved through a combination of further tuning the predictive algorithm and gaining access to better data.

### **Recommendation**

The demonstration, while not perfectly accurate today, validates that a data-based approach using voltage data from the SMN is possible, that the bandwidth exists to support this application, and it confirmed PG&E's expectation that SmartMeter™ data can be used to identify customer phase. This project initiative represents a first step towards identifying customer phase using SmartMeter™ data and provides additional justification to explore more challenging use cases as part of the *EPIC Project 2.14 - Automatically Map Phasing Information* project. With the ability to automatically determine the phase(s) to which customers are connected, PG&E can better manage and maintain the electric grid.

## **4.3 Enhancing the SmartMeter™ System for Outage Reporting**

Before the advent of SmartMeter™ devices, when an outage occurred, the only way to report outages was by customer phone calls. One of the greatest advantages of an extensive SMN is the ability to use its communication network to provide timely and accurate identification of outages, which greatly improves PG&E's ability to respond to them. When an outage occurs, the customer's SmartMeter™ is the first to know. When outages occur in the middle of the night or when the customer is away, the ability to use this data empowers PG&E to be able to restore power before the customer even knows that the power was out.

The following set of EPIC 1.14 initiatives were designed to provide additional evidence that SmartMeter™ outage data is accurate, reliable, timely, and complete. In addition, this EPIC 1.14 track seeks to demonstrate ways to *extend* the use of SmartMeter™ outage data to potentially enable faster restoration during major storm events and evaluate possible enhancements to the system.

### *4.3.1 Outage Reporting and Logging*

#### **Project Scope and Timeline**

The purpose of this initiative was to study the alarms and logs generated by the SmartMeter™ Network as well as identify recommendations to make those alarms and logs more reliable and useful to the Outage Management System (OMS). At the start of this project, there were a number of deficiencies in the outage reporting system involving message logging and reporting that made the process of discerning true outages from temporary voltage sag events and determining the precise time of power restoration more challenging. Although the primary purpose of this EPIC project was to demonstrate technologies, the outage track initiatives produced a number of recommendations that have been adopted by PG&E as part of non-EPIC funded projects.

The major tasks and deliverables of the Outage Logs initiatives were to:

- Use actual SmartMeter™ outage data to validate the Outage Theory of Operation and compare it to PG&E's current outage reporting system, Integrated Logging Information System (ILIS), in order to:
- Determine whether SmartMeter™ data might provide accurate reliability metrics such as MAIFI, SAIDI, SAIFI, and CAIDI.



- Identify potential ways to improve the accuracy of outage data so that it can be more useful to PG&E's outage inference engine.
- Isolate current bugs or defects where possible.

PG&E performed the following phases of analysis on SMN outage event logs:

### **Outage Wave 1**

- Phase I was conducted in Q1 2014, looking at outage data from September 6th/8th, 2013, comparing SmartMeter™ Outage data to outages reported in ILIS.
- Phase II was conducted in Q2 2014, based on outage data from February 12th, 2014, comparing data in both directions (ILIS to SmartMeter™ Data / SmartMeter™ Data to ILIS).
- Phase III was a study of outage event logs related to the August 24th, 2014 outage associated with the Napa Earthquake.
- Phase IV was a study of SmartMeter™ Outage event log data from October 3rd, 2014.
- Phase V was a study of the effects of the firmware modifications recommended after the first four Phases, looking at all outage data collected on January 20, 2015

### **Outage Wave 2**

Outage Wave 2 examined the effects of the changes implemented in the fourth quarter of 2015.

- Phase VI was a study of the effects of a significant firmware revision that corrected many of the issues that the PG&E had identified in Wave 1, looking at all outage data from November 22 and November 29, 2015.
- Phase VII was a study of the effects of implementing the Ignore Power Fail option on the most predominant SmartMeter™ type in the PG&E system, looking at data from December 15, 2015 and January 4, 2016.

During all phases, meetings were held between PG&E and its SmartMeter™ Network vendor to discuss findings and gather additional information about the outage theory of operations and issues observed during the study. In total, PG&E analyzed more than 900,000 outage events over the 29 months of the study period.

### **Technical Results and Findings**

PG&E validated that SmartMeter™ outage information is largely accurate, reliable, timely, complete, and provided recommendations for additional improvements to the outage reporting system. The following sections describe the findings, changes implemented to date as part of this EPIC project, and recommendations for future enhancements.

#### *Outage Theory of Operation*

The Electric SmartMeter™ system logs outage events in a pre-determined sequence. When a loss of power occurs, the meter's NIC performs a series of tasks:

- The NIC enters low-power mode and waits 100ms. If power is restored within the 100ms, the NIC logs a Momentary Power Disruption Event. If this power disruption lasts longer than 100ms, the NIC instead:
- Logs a Power Down Event; and
- Sends a “Last Gasp” message to its nearest neighboring device.

When a power loss occurs, the NIC should have enough reserve power for 300ms during which time it can properly log the outage event and send out a Last Gasp to its nearest neighbor device on the mesh network. However, PG&E discovered that in practice, the amount of power remaining and what can be accomplished during that 300ms is dependent on a variety of factors, including what the meter was doing at the time of the outage (sitting idly versus sending data), whether or not the meter is set to ignore slight voltage sags, how abruptly or slowly power is lost in a particular outage, and whether or not a particular outage is one of a series of up-and-down events caused by restoration operations, or by unstable current conditions associated with “wire-down” scenarios.

When the power is restored, the NIC performs a series of start-up tasks:

- Advances the boot counter.
- Sends a NIC Power Restore message.
- Logs a Power Restore Event.
- Synchronizes with network time.
- If the NIC correctly logs the time that the outage occurred and the time at which power was restored, it is simple to calculate the duration of the outage.

If multiple power failures occur, the NIC also logs how many times it reboots. These messages and traps can be used by PG&E’s Outage Management System (OMS) to efficiently identify outages, validate restoration, and accurately calculate the scope and duration of outages.

#### *Last Gasp Receipt Rates*

The receipt rate for Last Gasps varies with the size of an outage. While the intent is for each Last Gasp message to reach the data center, it may never reach its intended destination for a variety of reasons. When only one meter is affected, the Last Gasp completes its intended journey 82% of the time. However, in a more widespread outage, many of the Last Gasps will never reach the data center because they are sent to other meters that are also experiencing the same outage and may also fail due to network congestion. The following map illustrates this phenomenon:

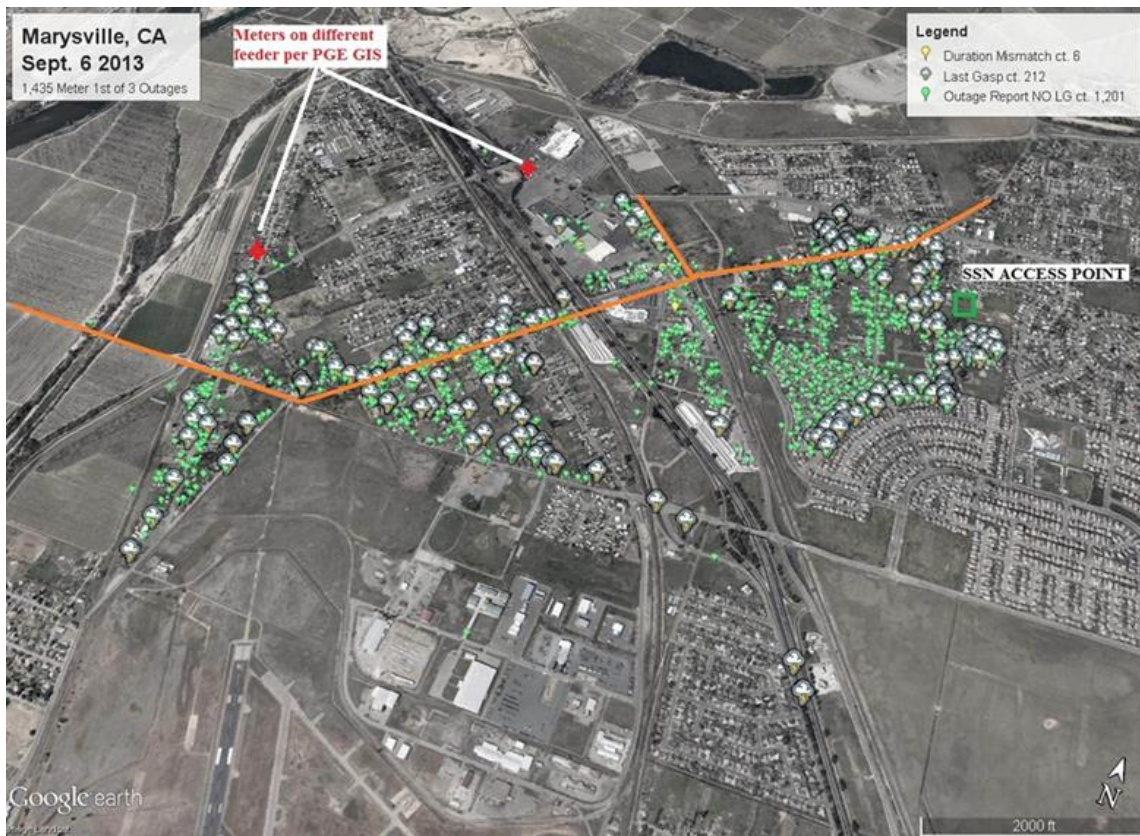

**Figure 14. Last Gasp Receipt During Major Outage**

Only the meters on the periphery of the outage (shown in white) were able to successfully send Last Gasps that were received by the data center. In a widespread outage, the percentage is often less than 20%. This is normal and expected, due to the fact that the meter only sends one Last Gasp, and since the meter’s NIC uses its last remaining power to send it, it is only attempted once. However, this does not mean that this information is not useful for determining outage location and severity. Indeed, once the patterns have been studied, it becomes clear that SmartMeter™ devices can be a valuable tool for quickly identifying and scoping outages.

**Recommendation (Implemented)**

At the start of this project, PG&E discovered lower than expected Last Gasp receipt rates, particularly on single-meter outages. Working with PG&E’s network vendor, a problem was discovered involving the way in which a meter chooses the randomly-assigned channel to use when sending a Last Gasp that caused some Last Gasps to not be sent. The problem was found to be in the NIC firmware, and a resolution was incorporated into the most recent firmware version, which has rolled out system-wide. This solution was implemented to support project objectives, but also benefited the wider system with no incremental cost.

During the course of this project, PG&E’s separate, non-EPIC funded Outage Phase II project added auto-pinging functionality to the Outage Management System (OMS) in May 2015. When the OMS receives a Last Gasp from a meter, it automatically pings other meters under that same transformer. With this auto-pinging capability, a Last Gasp from one meter enables the system to determine if the other meters under the same transformer are also out of power. This makes it possible to quickly scope the size of an outage even if a limited number of Last Gasps are received.

*Outage Notification Enhancement Data*

PG&E's network vendor offers an outage notification enhancement algorithm that provides meters with data about which neighboring meters share the same device (e.g., transformer, lateral, feeder, or substation). This enables meters to target a Last Gasp message to a neighbor on a different device. The intent is to increase the chance that the neighboring meter is on a different device and still in power (i.e., not experiencing the same outage), and therefore improve the odds that the Last Gasp will be received by the data center.

In order to find ways to potentially increase the receipt of Last Gasp messages during power PG&E analyzed the success rate of receiving Last Gasp messages before and after the use of this outage enhancement data to determine the impact of this data on Last Gasp success.

The outage notification enhancement data was installed on approximately 10,000 meters in PG&E's East Bay Division. PG&E looked at the ILIS outage records for all 10,000 meters in this Division over an eighteen-month period prior to the installation of this outage enhancement data and a twelve-month period after this data was installed. Last Gasp data was also analyzed for those meters over the same time period to calculate their receipt rates based on outage size and device level.

PG&E next looked at how Last Gasp data would be used by the Outage Inference Engine. The Outage Inference Engine identifies transformers that are experiencing an outage by identifying two or more meters sharing the same transformer that are out of power. By identifying as many transformers that are out of power as possible, the inference engine can then infer the outage upstream to the appropriate protective device.

PG&E then looked at the system-wide success rate of Last Gasp messages on transformer-only level outages, to determine if Last Gasp receipt rates without outage enhancement data are already sufficient to infer outages to transformers with the new auto-ping capability. PG&E focused on transformer level outages because more widespread outages are already being tracked by in-place systems.

Overall, PG&E observed a Last Gasp receipt rate of 17.1% before the installation of outage enhancement data, and 19.1% with the installation of outage enhancement data. For transformer-only outages, there was an improvement in Last Gasp receipt rates when outage enhancement data was installed, from 33.0% to 77.3%. However, with the introduction of the auto-ping functionality introduced during PG&E's Outage Phase II project (see above), this improvement provided minimal benefits, as the system already receives at least one Last Gasp in these situations a high percentage of the time, and in the sample that produced 33.0% Last Gasp receipts, at least 2 Last Gasps were received from 100% of the transformers in the sample without the outage enhancement data.

For distribution circuit-level outages, the percentages remained about the same before and after the implementation of outage enhancement data. But in larger distribution circuit-level outages (500+ meters), there was a decrease in Last Gasp receipt rates, from 24.1% to 18.2%.

For transmission line-level outages, there was an improvement from 1.6% to 8.7%. PG&E did not have comparative data for substation-level outages because there were no substation outages after the installation of outage enhancement data during the time period studied. However, in these cases, Last Gasp receipt rate percentages are not as critical because of the sheer number of Last Gasps received, and because SCADA and other system device monitoring information is available to scope the outage.

In cases where there is only one SmartMeter™ under a transformer – which typically indicates that the meter is in a very sparsely populated area – the meter's closest neighbor may not be nearby. While only

about 78.4% of Last Gasp for these single-meter outages are received, the cause of missing Last Gasp is not an outage at a neighboring meter and therefore would not be improved with outage enhancement data.

### **Recommendation**

Although outage notification enhancement data could have a positive impact on the overall number of Last Gasp received, it is unlikely to produce a meaningful increase in the number of transformers with at least one Last Gasp. In larger outages, sufficient Last Gasp are already received to scope outages, therefore any slight improvement in receipt rate would not have a meaningful benefit. In smaller outages (transformer level outages with few meters), outage enhancement data was determined to provide minimal benefit, and outage enhancement data could actually have a negative impact on Service Level outage receipt rates in areas where the meter population is sparse. PG&E's recommendation is to not proceed with installation of outage enhancement data, as it would not provide a good return on investment for ratepayers.

### *Battery Backed Relays for Improved Last Gasp Receipt*

Relays connect SmartMeter™ devices in the SMN to the APs that transmit data to the data center. If the Relay loses power in the event of an outage, it may not be able to transmit outage data. The goal of this initiative was to demonstrate the effects of adding batteries to Relays to see if this could increase the number of Last Gasp received.

Relays serve an important function in the SMN by helping to improve mesh connectivity. A mesh network, by its very nature, is constantly surveying connections and determining the best route from device-to-device for moving data from its origin to its destination. Should one device (meter, AP, Relay, etc.) become unavailable, the network "self-heals" to work around the unavailable device.

None of PG&E's Relays are currently backed by batteries. The major task for this sub-initiative was to demonstrate the potential impact of adding battery-backed Relays to PG&E's SMN to improve the receipt of Last Gasp messages from meters during an outage<sup>9</sup>.

With the aforementioned Outage Phase II auto-ping functionality in place, PG&E decided to use the criteria of one Last Gasp per transformer to be the requirement to infer an outage. Given that criteria, the situations where the Last Gasp receipt rates were below 95% were for transformers serving 1-3 meters.

PG&E assessed the current receipt rate of Last Gasp messages and identified situations where the receipt rate was below 95%. PG&E then looked at historical data to determine whether the Last Gasp receipt rate was lower in situations where a local Relay lost power during an outage.

PG&E surveyed the historical data for outages from January 2012 through October 2014 to determine if the Last Gasp receipt rate is lower in situations where the Relay lost power during an outage. If this data had identified situations where the Last Gasp receipt rate was lower when the Relay lost power, PG&E would have conducted field tests to determine whether adding battery-backed Relays would improve the Last Gasp receipt rate.

---

<sup>9</sup> There are other business reasons for adding battery-backed Relays to the SmartMeter™ Network, however they were beyond the scope of this initiative.

PG&E determined that transformers serving a single meter would not benefit from battery-backed Relays because they tend to be located in remote locations where the mesh coverage is weak, and in most cases, when these areas experience an outage, the nearest Relay tends to stay in power.

Therefore, the only situations where the Last Gasp receipt rate is below 95% were 2- and 3- meter transformers. PG&E found that outages affecting Relays in these situations only comprised 2.1 % of the total outages involving these transformers in the 2.5 years of outage data surveyed, and of those, only 0.16% failed to receive at least one Last Gasp.

**Recommendation**

Given the fact that only one Last Gasp is now needed to infer an outage to a transformer, as this situation now triggers a ping to be sent from the OMS to the other meters under that transformer, and given the low percentage of outages where there were 3 or fewer meters under a transformer and the local Relay lost power, PG&E determined that there is currently no need to develop a business case for installing battery-backed Relays in order to improve the receipt of Last Gasp.

*Restoration Message Receipt Rates*

One of the goals of this EPIC outage initiative was to determine if there could be ways to improve the receipt rate for outage restoration messages. Receiving the greatest number of restoration messages as quickly as possible can help PG&E to better manage work crews, which results in faster power restoration after an outage.

One reason why it sometimes takes longer to receive a restoration message is because, as the network is self-healing, restorations don't necessarily occur at exactly the same time. Typically, it takes about 3 minutes after power is restored for a meter to power up, perform a time sync with the network, and complete restoration message logging. Therefore, if meters closer to the AP are restored after meters that are farther away, this can cause a delay in the receipt of a restoration message.

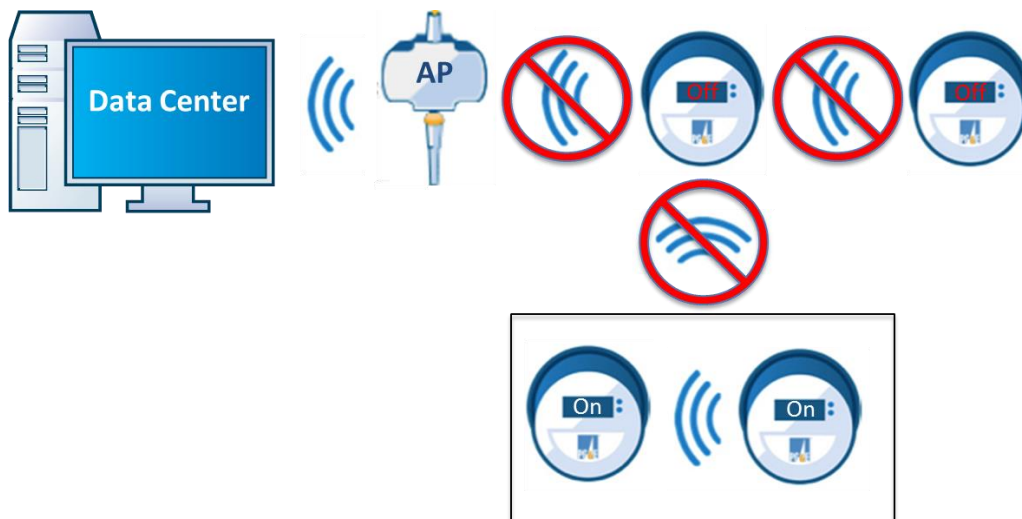

**Figure 15. Restoration Message Receipt as the Network Is Self-Healing**

**Recommendation (Implemented)**

Working with its network vendor, PG&E identified ways to improve the receipt rate of restoration messages. These changes were integrated into the most recent version of the firmware, which was evaluated under Wave 2 of this initiative. Under the older version of the firmware, Restore Traps took an average of 3.5 minutes to be received, and under the new version, the average receipt rate improved to 2.8 minutes. In the first few minutes after power is restored, the receipt rate was slightly faster under the older firmware, but by 8 minutes after restoration, the receipt rate is better under the new firmware. Restore traps taking longer than 30 minutes to be received were reduced significantly with the firmware update – from 1.1% to less than 0.2%. The Overall Restore Trap receipt rate dropped slightly from 99.8% to 99.5%, however, the rate was 99.9% excluding three large outages with staggered partial restorations. Another factor was the relatively short study period in Wave 2.

In addition, PG&E has recommended a feature to have configurable delay before attempting to send a restoration message. When power is ultimately restored (long enough for a time-sync with the network), PG&E found that Restore Traps are received 99.5%-99.9% of the time.

*Message Log Filtering*

In studying the SmartMeter™ outage message logs at the start of this initiative, PG&E noted a number of issues that made discerning valuable outage information more challenging.

When the system is being repaired, or when voltage conditions are unstable, there may be a number of temporary restorations in power that occur which can cause the meter's NIC to send a restoration message, only to have the power go out again. It can be challenging to try to discern true outages from these temporary restorations that may occur while the system is being repaired.

In addition, PG&E observed that a relatively small number of meters were producing a proportionately large number of logged events in a given day. Most of these meters are in an exception state or are temporarily "distressed," and do not provide useful outage data.

**Recommendation (Implemented):** PG&E determined methods to filter out messages from "distressed" meters from the data that gets integrated into DMS. After filtering, which a non-EPIC funded project implemented, the remaining outage messages provide accurate and useful data regarding the timing and duration of outages. The messages from these "distressed" meters are still logged so that if these meters require attention, the problem can be addressed.

PG&E also noted several issues involving incorrect timestamps for outage events. While the major timestamp issues have been resolved with the latest version of the firmware, PG&E has been working with its IT department and with the network vendor to resolve the remaining minor issues.

*Erroneous Outage Messages 1 – Incomplete Logs*

In the early phases of the project, PG&E identified a number of instances where the outage logs were incomplete, and situations where the NIC logged a "Power Down – Cause Unknown" event that does not provide an accurate timestamp. These incomplete logs and Power Down – Cause Unknown events were brought to the attention of the network vendor.

**Recommendation (Implemented)**

Working with PG&E's network vendor, improvements to the NIC firmware were identified to reduce erroneous outage messages. In particular, PG&E worked on reducing the incidence of incomplete logs, and in the latest version of firmware, incomplete logs were reduced from 4.3% to 1.3%, and Power Down

– Cause Unknown events were reduced from 4.6% to 1.6%. In Outage Wave 2, PG&E confirmed that the firmware update, which was deployed by a non-EPIC funded project, corrected many of these issues.

#### *Erroneous Outage Messages 2 – Voltage Sags*

Another cause of erroneous outage messages was partial voltage sags which caused certain meters to send a Last Gasp message, even though the power was not completely out. To resolve this, PG&E recommended enabling the a feature on the meter’s NIC to “Ignore Power Fail” which prevents the NIC from powering down on a voltage sag and sending an erroneous Last Gasp message.

#### **Recommendation**

PG&E demonstrated that there is currently a trade-off in implementing Ignore Power Fail: by enabling IPF, unwanted outage events on voltage sags are eliminated; however, Last Gasp receipt rates are lower and the occurrence rates of Power Down – Cause Unknown events are higher without the Power Fail warning. Given that choice, PG&E’s recommendation at this time is to leave IPF enabled on these meters, as the improvement to reliability of outage messaging and logging by removing erroneous power loss events on voltage sags outweighs the slight decrease in Last Gasp receipt rates and Power Down – Cause Unknown events. In the longer term, PG&E has recommended that its network vendor make changes to the message logging system to make it easier to differentiate voltage sags from complete outage events.

#### *Erroneous Outage Messages 3 - Identifying Spamming Meters*

In some instances, certain meters produce an excessive number of erroneous outage messages, or “spam.” PG&E investigated why this occurs. Sometimes, after a power interruption, certain meters become “distressed” and send out excessive erroneous outage messages. Sometimes these meters correct themselves, but in other cases, they do not. Because these meters may require attention, their messages should continue to be logged, but their messages should be filtered out of the pool of outage messages that get passed on to the DMS for outage identification purposes.

#### **Recommendation**

To filter out spamming meters, PG&E also recommends reconfiguring the way that the system identifies meters that send excessive erroneous outage event messages and ignores messages from those meters for a set period of time. PG&E recommended an update to the filtering logic for spamming meters, which is being evaluated by the network vendor.

### **Overall Outage Logging and Messaging Conclusions**

The results indicate that SmartMeter™ outage data for active meters is timely, accurate, and reliable, but requires screening and remediation to provide useful information for outage tracking. After applying screening and remediation, the Electric SmartMeter™ system:

- Provides detailed, accurate outage durations;
- Accurately identifies which meters are experiencing an outage;
- Receives Last Gasps at a rate that is highly dependent of the size of the outage, ranging from approximately 82% for smaller outages down to 15% for larger outages. Due to the absolute number of Last Gasps received, and the tendency for the those messages to be received from meters near the periphery of the outage, these percentages are sufficient to infer the scope of the outage;
- Receives 99.9% of Restore Traps, the vast majority of which are received within 10 minutes, with an average receipt time of 2.7 minutes, which is adequate data to infer restoration in a timely manner.



### 4.3.2 Outage Data for Major Storms

This initiative demonstrated the ability of data collected from PG&E’s SmartMeter™ devices to enhance outage reporting during major storm events. The initiative evaluated the technical feasibility and business practicality of utilizing additional SmartMeter™ information for enhancing real-time outage tracking as well as post-event record management.

The major tasks and deliverables for this initiative were to assess the ability of SmartMeter™ messaging data to be utilized for three main objectives:

- In real-time, attempt to determine if all customers have been restored following a system repair. This would help to verify whether there are customers that the Outage Management Tool (OMT) shows to have been restored but who are actually still out, potentially due to a “nested” outage or similar event.
- In real-time, attempt to utilize SmartMeter™ data to provide a more accurate count of how many customers have been restored since the beginning of the outage.
- After an event, attempt to utilize SmartMeter™ data to supplement ILIS records to more accurately capture customer outage times for calculation of CAIDI metrics, in a side-by-side comparison.

The following data was used in this initiative:

*SmartMeter™ Network Data:*

- Meter Last Gasps (produced when a meter loses power due to a variety of situations)
- Meter Power Restore (produced when a meter initially regains power)
- Trap Spammer (produced when meter’s Network Interface Card (NIC) has exceeded the number of allowable traps in a configurable period)
- Comms Cleared (produced when a meter has cleared a communications-related condition)
- SmartMeter™ Events – events collected in the NICs Event Log and retrieved as part of the standard 4-hour meter read job

*Distribution Management System (DMS) Data:*

- DMS Verified Service Outage – as defined by DMS logic, including updates to the outage.
- DMS Outage Transformer data – listing of transformers involved in a unique outage as defined by Outage Information System (OIS) record.

### Technical Results and Findings

The near-real-time SmartMeter™ and outage data was used to visualize outage restorations both as they were occurring and later for historical analysis. PG&E created a prototype Restoration Dashboard, which displayed near-real-time outage data on a map.

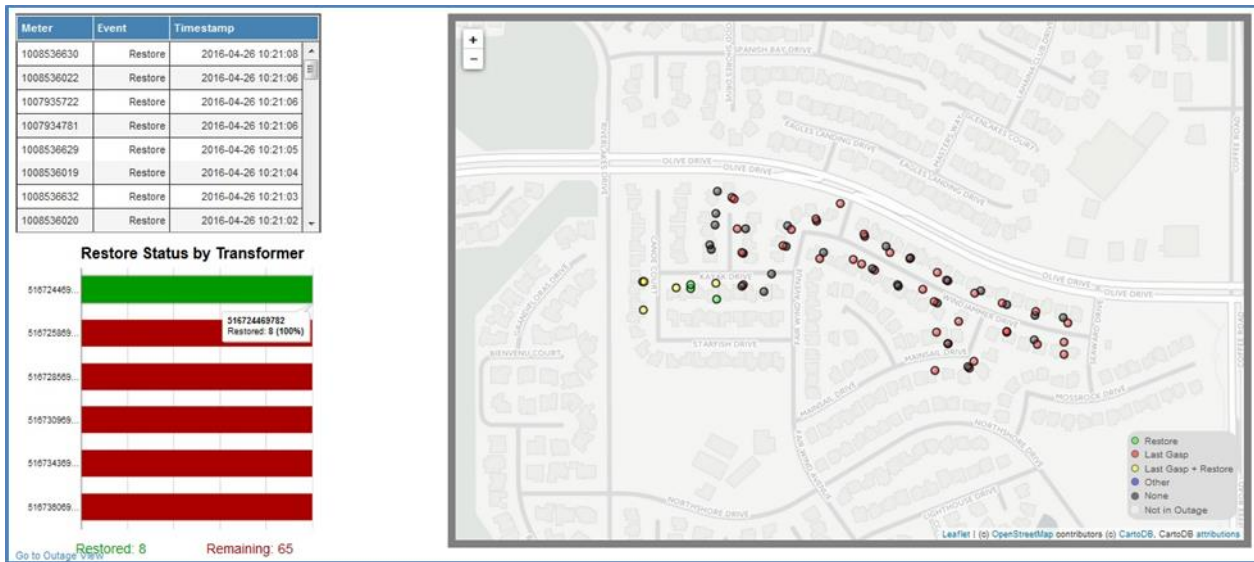

Figure 16. Restoration Dashboard

The dashboard could also be used to pinpoint nested outages. Figure 17 shows an outage that may appear to be ready to close based on the restoration efforts in the field, but shows that none of the meters from one of the affected transformers has issued any Restore Traps, possibly indicating a secondary issue with that transformer.

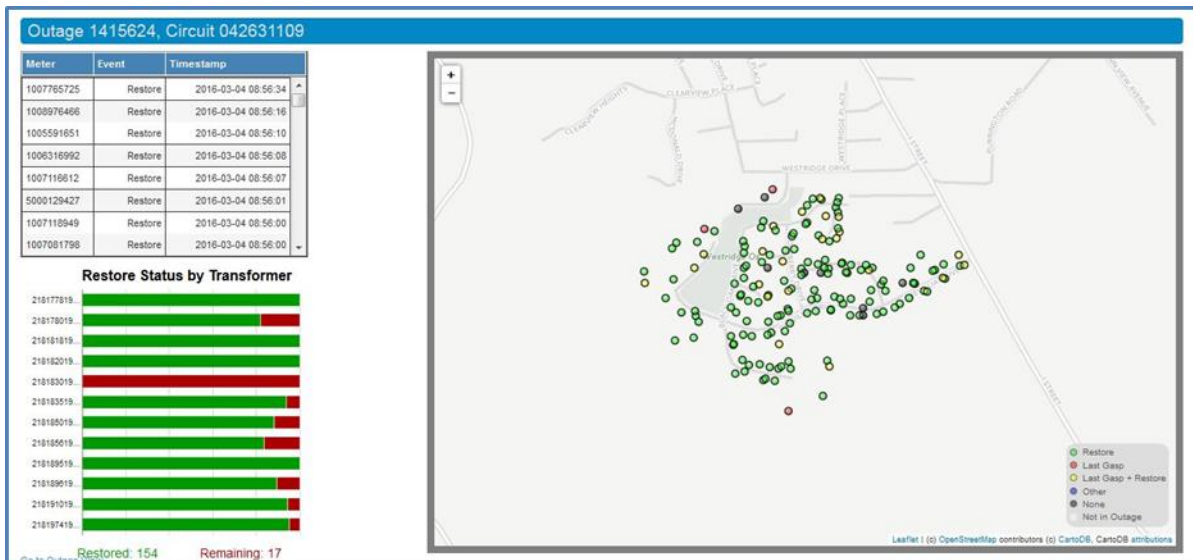

Figure 17. Nested Outage

**Recommendation**

That the Restoration Dashboard demonstration application be used as a basis for a future DMS system.

**Side-by-Side Data Analysis**

To determine the accuracy of SmartMeter™ data for outages, PG&E compared information gathered from the SmartMeter™ outage logs against information from FocalPoint (the standardized reporting platform for

transformer-level outages and above) in a side-by-side data analysis. PG&E looked at data from a total of 431,668 meters involved in 3,182 distinct sustained outages in this analysis.

### **Recommendation**

After reviewing the results of the analysis, PG&E has identified three key ways in which SmartMeter™ data can be effectively used to enhance outage records:

- To identify and eliminate meters not impacted by an outage. When a SmartMeter™ does not produce a Last Gasp or log any Power Down/Up events, Restore Traps, or low voltage events, and it records ordinary meter reads during the outage period, the data indicates that the meter did not experience an outage. Using SmartMeter™ data in this way can be useful in single-phase outage situations, as well as 2- and 3-phase outage conditions where only certain meters experienced the outage.
- To better determine restoration actions that occurred in the field. This would provide an incremental benefit in cases where restoration actions cannot be automatically documented (via SCADA device or otherwise).
- To better calculate Customer Minutes for Complete Out meters. However, using SmartMeter™ data to effectively calculate outage durations requires filters in addition to the ones that are currently in place.

## 5 Project Key Results and Conclusions

The key findings of the *EPIC 1.14 Next Generation SmartMeter™ Telecom Network Functionalities* Project are of interest to PG&E and the wider utility industry. This project demonstrated a proof of concept that PG&E's AMI infrastructure can help support certain Smart Grid applications and devices.

### Capabilities of the SmartMeter™ Communications Network

While the primary functions of the SmartMeter™ Communications Network include support of day-to-day metering operations, the SMN is also potentially capable of supporting advanced Smart Grid devices and applications, which have the potential to reduce costs and improve system reliability.

- *Bandwidth*  
The SMN is reliable and capable of supporting additional applications and devices without impacting day-to-day customer metering operations. Daily metering operations only use about 15-20% of the available bandwidth on the Electric SMN.
- *Network Management Visualization*  
This project also demonstrated tools and visualization techniques that might help PG&E to better manage the SMN. These tools can help to point out weak areas of the mesh network and thereby improve system reliability and reduce operational costs.
- *Network Support for Smart Grid Devices Applications*  
The network is able to transmit other types of network traffic, such as streetlight and distribution automation control and telemetry, without impeding day-to-day metering operations. This demonstrates that the Electric SMN might be leveraged to support future smart grid applications and devices.

As a result of these initiatives, PG&E has adopted the network analysis methods used in this EPIC project to evaluate the SMN going forward, and has collected data that supports confidence in the SMN's capabilities to enable its use in other Smart Grid projects, such as the Line Sensor and Fault Detection and Location projects.

### Leveraging the SmartMeter™ Network for Smart Grid Devices and Applications

Smart Grid devices may offer functionalities to support more efficient and reliable services for California communities. The SMN network is also potentially capable of supporting applications and devices that can improve PG&E's ability to safely deliver energy. Smart grid applications may help PG&E deliver energy more efficiently and safely in a changing world where electric vehicles and solar generation are increasingly adopted.

- *Smart Streetlights*  
Adding networked photocells to existing streetlights not only provides the ability to remotely control and monitor streetlights, they may also provide the ability to accurately meter the lights' electric usage and can strengthen the SmartMeter™ Network. PG&E is considering evaluating the business case for installing SMN-capable photocells into its LED Streetlight Replacement project, which may benefit PG&E customers, improve public safety, and reduce emissions.
- *SmartPoles*  
The ability to deploy a small-footprint, metering solution to civic and corporate telecommunications customers can reduce bulky, unattractive metering equipment, and supports accurate energy usage measurement in situations where usage is currently billed at a flat rate, or not billed at all. SmartPoles can also help to strengthen the SmartMeter™ Network. As a result of this successful EPIC demonstration, PG&E's evolving customers could benefit from this new small-footprint meter.

- *Next Generation Network Hardware*  
Newer network hardware compatible with PG&E’s SmartMeter™ Network can be integrated into the current network, and has the potential to strengthen the network in certain areas. As a result of this successful EPIC demonstration, PG&E has increased confidence that newer network hardware should not adversely impact the SMN, and indeed might strengthen it and progress PG&E’s smart grid initiatives.
- *Distribution Automation Communications*  
The ability to route Distribution Automation traffic over the existing SmartMeter™ Network has the potential opportunity to replace costly radio modem communications and reduce congestion on the network. As a result of this successful EPIC demonstration, PG&E has the confidence to evaluate this technology further, which has the potential to reduce both system congestion and monthly telecommunications costs, which would benefit both customers and the utility.
- *Transformer Monitoring*  
Lower-cost transformer monitoring solutions that can take advantage of the SmartMeter™ Network have the potential to provide a cost-effective means of safely monitoring smaller transformers that are not currently being monitored. As a result of this successful EPIC demonstration, PG&E recognizes that SMN-based transformer monitoring is an emerging technology worth pursuing, to enhance both system reliability and public safety.
- *Voltage Data Collection*  
The ability to use SmartMeter™ devices collect voltage readings throughout PG&E’s service territory can help PG&E to better and more safely monitor and maintain the electric grid. As a result of this successful EPIC demonstration, PG&E may use these voltage monitoring recommendations for other projects that require voltage data, to provide a consistent methodology for using SmartMeter™ voltage data.
- *Phase Identification*  
The potential ability to automatically determine the phase(s) that customers are connected to can help PG&E to better manage and maintain the electric grid. This project initiative represented a first step towards identifying customer phase using SmartMeter™ data and provided the confidence to explore more challenging use cases as part of the *EPIC 2.14 Automatically Map Phasing Information* project. With the ability to automatically determine the phase(s) to which customers are connected, PG&E can better manage and maintain the electric grid.

**Enhancing the SmartMeter™ System for Outage Reporting**

The system of outage alerts and messages built into the SmartMeter™ system can improve PG&E’s response time in the event of an outage, and can be of particular value during storm season to help PG&E to quickly identify and scope outages. As a result of the EPIC 1.14 Outage initiatives, PG&E has gained additional confidence in using SmartMeter™ outage data to enhance outage identification and restoration efforts to enable faster restoration and enhance safety and reliability, and has shared these findings with other IOUs. Key recommendations from these initiatives include:

- *Outage Reporting and Logging*  
SmartMeter™ outage data has proven on the whole to be reliable and can provide timely information that can accurately identify which meters are experiencing an outage, and the duration of each outage. In the process of determining this, PG&E identified and resolved a number of data integrity edge cases. For example, “Last Gasp” receipt rates were found to be lower than expected in specific circumstances, and firmware updates were rolled out system-wide to resolve this.

- *Outage Data For Major Storms*  
PG&E created a prototype Restoration Dashboard to visualize progress in resolving outages following major storms. This application could be used to target restoration activities more effectively, and improve the calculations of Customer Outage Minutes following an outage. This functionality should be considered for integration into a future Distribution Management System.

## 5.1 Data Access

Upon request, PG&E will provide access to non-confidential data collected that is consistent with the CPUC's data access requirements for EPIC data and results.

## 5.2 Value Proposition

The purpose of EPIC funding is to support investments in technology demonstration and deployment projects that benefit the electricity customers of PG&E, San Diego Gas and Electric (SDG&E), and Southern California Edison (SCE). *EPIC 1.14 Next Generation SmartMeter™ Telecom Network Functionalities* has demonstrated that the SMN is capable of supporting additional technologies and devices to further Smart Grid efforts, improve outage restoration, and improve the safety and efficiency of the electric grid at a reduced cost.

Many of the recommendations from this EPIC project have already been accepted and implemented at PG&E as a result of this pilot. The network bandwidth analysis methodology developed for this project has been adopted for use in other projects. The demonstration of the capabilities of the SMN to handle other forms of traffic has prompted other Smart Grid projects, such as the wireless Line Sensor project, to explore using the SMN for communications. The voltage monitoring recommendations developed for this project have been foundational for helping PG&E to develop a voltage monitoring strategy. The groundwork begun in this project for phase identification has provided the confidence to proceed with the EPIC 2.14 Automatic Phase Identification project. Many of the recommendations for outage reporting firmware updates and application changes have been implemented and have been successful.

### 5.2.1 Primary Principles

The primary principles of EPIC are to invest in technologies and approaches that provide benefits to electric ratepayers by promoting **greater reliability**, **lower costs**, and **increased safety**. This EPIC project contributes to these primary principles in the following ways:

- **Greater Reliability**  
The *EPIC 1.14 Next Generation SmartMeter™ Telecom Network Functionalities* project demonstrated technologies that may provide greater reliability through potential improvements in outage reporting, distribution automation control and telemetry, and monitoring and control of the electric grid.
- **Lower Costs**  
Leveraging the SMN for non-metering applications and devices (that would otherwise require a separate communications network) may have the potential to lower costs for smart grid devices and applications that can help PG&E to deliver energy safely and efficiently. Innovative metering solutions such as Smart Streetlights and SmartPoles can enable PG&E to more accurately meter electricity use.
- **Increased Safety**  
Monitored and controlled streetlights have the potential to improve safety by increasing the streetlight intensity when crews respond to emergency situations, and automatically alerting PG&E

when bulbs burn out. Lower-cost networked transformer monitoring solutions may enable PG&E to monitor smaller transformers, and receive alerts before a transformer fails.

### 5.2.2 Secondary Principles

EPIC also has a set of complementary secondary principles, and of which this EPIC project contributes to the following three:

- **Societal Benefits**  
Smart Streetlights can be dimmed remotely, allowing communities to prevent excessive light pollution. SmartPole meters may provide the ability to implement small-footprint metering solutions which reduces the need to place metering equipment at street level, and are more aesthetically pleasing than standalone metering solutions
- **Economic Development**  
Smart grid technologies in general may have the potential to create new markets for more efficient devices, new sensing and communications capabilities, and PG&E's vision for the Grid of Things™ (GoT). Confirming additional communication channels for these devices improves their value proposition and market potential.
- **Efficient Use of Ratepayer Monies**  
If the existing SMN can be used to support future smart grid applications and devices, PG&E might not need to deploy a new network or rely on more costly communications solutions. In evaluating next generation network hardware, PG&E explored through EPIC whether this hardware would have a compelling cost advantages for the company and its customers. Carefully choosing technologies and methodologies to better manage the SMN, such as producing a company-wide voltage collection methodology strategy or evaluating ways to enhance outage notification messaging, is a step towards potential savings for ratepayers.

## 5.3 Technology Transfer Plan

### 5.3.1 IOU's Technology Transfer Plans

A primary benefit of the EPIC program is the technology and knowledge sharing that occurs both internally within PG&E and externally across other investor-owned utilities (IOUs), the California Energy Commission (CEC), and the industry. In order to facilitate this knowledge sharing, PG&E will share the results of this project in industry workshops and through public reports published on the PG&E website. PG&E has presented information about the network bandwidth capabilities at the DistribuTECH conference, and with other utilities that use the same network technology. Specifically, below is information sharing forums where the results and lessons learned from this EPIC project were presented or plan to be presented:

### **Information Sharing Forums Held**

- *SSN Connections – San Diego, CA | February 2, 2015*
- *DistribuTECH – San Diego, CA | February 2-5, 2015*
- *AMI Outage Summit – Chicago, IL | June 23-24, 2015*
- *AMI DA Conference – San Antonio, TX | August 10, 2015*
- *AMI User Group Meeting – Redwood City, CA | September 22, 2015*
- *SSN Connections – Orlando, FL | February 8, 2016*
- *DistribuTECH – Orlando, FL | February 9-11, 2016*

### **Information Sharing Forums Planned**

- *2017 Edison Electric Institute Conference – Boston, MA | June 11-14, 2017*
- *AMI User Group Calls – Conference Call | Bi-Monthly*

### **5.3.2 Adaptability to Other Utilities / Industry**

Utilities across the country are deploying AMI and smart grid systems in their service territories. Many of the key learnings from this project are important for consideration in those deployments, however the following findings of this project are particularly relevant and adaptable to other utilities and the industry:

- **SmartPoles (4.2.2)**

Almost every electric utility has had requests for telecommunication equipment mounted on streetlights or power poles. The small footprint meter would give utilities the ability to meter loads in confined spaces and telecom equipment mounted on streetlights and power poles to reflect their actual energy usage. This can eliminate the current practice of billing these loads at a flat rate, or in some cases, not metering and billing them at all. In cases where a meter is needed, a small footprint meter mounted on the top of a pole could save costs by eliminating the need for stand-alone metering pedestals set next to the pole or a meter panel attached onto the pole.

- **Distribution Automation (4.2.4)**

As the smart grid becomes increasingly more complex, utilities need to deploy increased sensing and control devices to monitor an ever-changing grid. The ability to use the AMI network to communicate with automated distribution devices, rather than a dedicated network or costly cellular communications can increase affordability for all ratepayers.

- **Low-Cost Transformer Monitoring (4.2.5)**

Transformer accidents from small residential transformers are a potential danger to communities. Widespread market availability of a low-cost transformer monitoring technology that could communicate via an AMI mesh network and could provide advance warning of transformer failure would greatly reduce the potential for transformer accidents.

- **Accurate Outage Data and Reporting Methods (4.3)**

AMI technology is a valuable tool for providing accurate and timely outage data. The ability to further refine and take advantage of this data to provide more timely restorations is relevant to the entire industry and customers.

Many utilities leverage the same telecommunications network technology as PG&E's SMN. However, each utility's implementation of that technology is unique. Over this course of this EPIC project, PG&E has coordinated with and consulted other utilities around the country who are also exploring and deploying these technologies to share information and key learnings.



## 6 Metrics

The following metrics include more than were identified in the EPIC Annual Report for this project. Given the proof-of-concept nature of this EPIC project, these metrics are forward looking, which identify benefits that may be feasible to achieve upon full scale deployment of the recommended aspects of this project.

**Table 6-1. EPIC Project Metrics for Potential Benefits**

<b>D.13-11-025, Attachment 4. List of Proposed Metrics and Potential Areas of Measurement (as applicable to a specific project or investment area in applied research, technology demonstration, and market facilitation)</b>	<b>See Section</b>
<b>1. Potential energy and cost savings</b>	
<i>b. Total electricity deliveries from grid-connected distributed generation facilities</i> Using SmartMeter™ data to identify the phase that a customer is connected to may help PG&E to perform better load balancing.	4.2.7
The ability to support lower-cost transformer monitoring has the potential to increase the number of transformers that can be monitored to avoid reverse flow overloads.	4.2.5
<i>f. Avoided customer energy use (kWh saved)</i> Smart Streetlights could enable reduced energy consumption due to adaptive controls.	4.2.1
<i>h. Customer bill savings (dollars saved)</i> Smart Streetlights and SmartPoles might enable an easier and more cost effective means to offer metered rates.	4.2.1 4.2.2
<b>3. Economic benefits</b>	
<i>a. Maintain / Reduce operations and maintenance costs</i> Potential cost avoidance from leveraging the SmartMeter™ Network to accommodate non-AMI traffic rather than maintaining or deploying other communication paths.	4.1.1 4.1.3
Lower cost Transformer Monitoring may provide the ability to better support condition-based maintenance, optimize operation of transformers, support voltage reduction, and verify load reduction.	4.2.5
The Smart Streetlights project demonstrated underlying technology that may enable the following benefits with a full deployment to PG&E owned streetlights: reduced call center volume due to calls about light issues (e.g. bulb out), better asset management, and proactive maintenance.	4.2.1
Enhancing SmartMeter™ Outage capabilities may help to scope and identify outages, allowing better and more cost efficient targeting of response.	4.3
<i>b. Maintain / Reduce capital costs</i> Leveraging the SmartMeter™ Network to accommodate non-SmartMeter™ traffic means that PG&E might not need to build / expand other communication paths.	4.1.1 4.1.3 4.2.4
<b>4. Environmental benefits</b>	
<i>a. GHG emissions reductions (MMTCO<sub>2</sub>e)</i> The Smart Streetlights project demonstrated underlying technology that may enable reduced wasted energy by identifying day-burners and reduced CO <sub>2</sub> emissions due to energy savings.	4.2.1

D.13-11-025, Attachment 4. List of Proposed Metrics and Potential Areas of Measurement (as applicable to a specific project or investment area in applied research, technology demonstration, and market facilitation)	See Section
<b>5. Safety, Power Quality, and Reliability (Equipment, Electricity System)</b>	
<p><i>a. Outage number, frequency and duration reductions</i> By improving the usability of outage messaging and logging from the electric system, outages can be scoped more efficiently, restorations can be confirmed more quickly, and outage durations can be reduced. Delivering near real-time data helps with outage management as well.</p>	4.3
<p><i>d. Public safety improvement and hazard exposure reduction</i> Monitored and controlled streetlights have the potential to improve safety by increasing the streetlight intensity when crews respond to emergency situations, and well as potentially automatically alerting PG&amp;E when bulbs burn out.</p>	4.2.1
<p>Low-profile metering solutions that locate the electric metering equipment above street level can help to reduce hazards to pedestrians.</p>	4.2.2
<p>Low-cost transformer monitoring can provide an approach to support avoided transformer overload failures and provide better loading data.</p>	4.2.5
<p><i>h. Reduction in system harmonics</i> Low-cost transformer monitoring may provide an approach to help identify transformer overheating due to harmonics.</p>	4.2.5
<p><i>i. Increase in the number of nodes in the power system at monitoring points</i> The Voltage Collection project analyzed and recommended a low-cost methodology to use existing SmartMeter™ to collect instantaneous voltage readings. By reprogramming the SmartMeter™ NIC to include a voltage channel, every SmartMeter™ might have potential as a voltage monitoring point.</p>	4.2.6
<p>A widespread application of SmartPoles may provide additional monitoring information at a lower cost than traditional SCADA equipment.</p>	4.2.2
<b>7. Identification of barriers or issues resolved that prevented widespread deployment of technology or strategy</b>	
<p><i>b. Increased use of cost-effective digital information and control technology to improve reliability, security, and efficiency of the electric grid (PU Code § 8360)</i> The SmartMeter™ Network Bandwidth initiative demonstrated the ability to leverage the existing SmartMeter™ infrastructure investment to support additional data transmission beyond day-to-day metering operations.</p>	4.1.1
<p>The network visualization techniques demonstrated may reduce the amount of analytics efforts needed for future projects that utilize the SmartMeter™ mesh network as a communications medium for non-metering devices (e.g., wireless line sensors).</p>	4.1.2
<p>The ability to identify the phase to which a customer is connected using SmartMeter™ data may lead to accurate connectivity, which is foundational to high levels of automation; success in this area would also support higher levels of DG connectivity as well as voltage regulation.</p>	4.2.7
<p>Low-cost transformer monitoring provides an approach to support higher levels of DG connectivity while leveraging the SmartMeter™ Network. The challenges of using the HAN</p>	4.2.5

<b>D.13-11-025, Attachment 4. List of Proposed Metrics and Potential Areas of Measurement (as applicable to a specific project or investment area in applied research, technology demonstration, and market facilitation)</b>	<b>See Section</b>
<p>capabilities of the SmartMeter™ Network identified potential barriers in firmware and software that would need to be addressed in order for this Smart Grid technology to be put into practice.</p> <p>The Smart Streetlights project demonstrated underlying technology that will enable the following benefits with a full deployment to PG&amp;E-owned streetlights: improved mesh network without having to install relays to connect remote meters, improved safety and reliability as a result of alerts and proactive maintenance, streetlight-specific asset management system, easier to adjust light output (avoids shielding), and customer control over their lights.</p> <p>The SmartMeter™ Outage initiatives identified ways to screen data, reducing “false positive” data, making the data more useful and made recommendations regarding the usability of event log entries. These initiatives demonstrated the ability to deliver near real-time data to help with outage management.</p>	<p>4.2.1</p> <p>4.3</p>
<p><i>f. Deployment of cost-effective smart technologies, including real time, automated, interactive technologies that optimize the physical operation of appliances and consumer devices for metering, communications concerning grid operations and status, and distribution automation (PU Code § 8360)</i></p> <p>Using the SmartMeter™ Network for DA Communications might enable a lower cost means of communicating with SCADA devices.</p>	<p>4.2.4</p>
<p><i>k. Develop standards for communication and interoperability of appliances and equipment connected to the electric grid, including the infrastructure serving the grid (PU Code § 8360)</i></p> <p>Using the SmartMeter™ Network for DA Communications may support communication with SCADA devices.</p>	<p>4.2.4</p>
<p><i>l. Identification and lowering of unreasonable or unnecessary barriers to adoption of smart grid technologies, practices, and services (PU Code § 8360)</i></p> <p>The SmartMeter™ Network Bandwidth initiative established a general profile of network utilization and a repeatable methodology for monitoring that utilization. PG&amp;E demonstrated that additional bandwidth is available for deploying new Smart Grid technologies over the network. PG&amp;E socialized findings and obtained sign-off on both results and methodology, which will be adopted by other groups.</p> <p>Next generation network hardware may provide increased throughput between fourth generation devices while still communicating with legacy network equipment, which might help facilitate the introduction of non- SmartMeter™ traffic on the SmartMeter™ Network.</p> <p>The SmartMeter™ Voltage Data Collection initiative demonstrated various voltage data collection and extraction techniques and established a use case matrix compiled from multiple business stakeholders to quantify the broad range of use cases and requirements. PG&amp;E organized meetings to educate key business stakeholders and IT services teams in an effort to deliver a prescriptive solution outline.</p>	<p>4.1.1</p> <p>4.2.3</p> <p>4.2.6</p>

D.13-11-025, Attachment 4. List of Proposed Metrics and Potential Areas of Measurement (as applicable to a specific project or investment area in applied research, technology demonstration, and market facilitation)	See Section
<b>8. Effectiveness of information dissemination</b>	
<p><i>d. Number of information sharing forums held</i>                      PG&amp;E held phone discussions with utilities, in person meetings with CA IOU's, and submitted presentations for industry conferences. They also led business and technology review sessions with senior management, steering committees, and IT &amp; network architects</p> <p>PG&amp;E created and led an Outage Management focus group as part of an AMI User Group. This provided a forum to share, compare, and discuss the results of this initiative with other US utilities and the network vendor.</p>	<p>5.3.1</p> <p>4.3</p>
<b>10. Reduced ratepayer project costs through external funding or contributions for EPIC-funded research on technologies or strategies</b>	
<p><i>a. Description or documentation of funding or contributions committed by others</i>                      The vendor donated their time for performing the time series calculations for the Phase ID initiative.</p>	4.2.7

## 7 Conclusion

PG&E has invested in a robust AMI network and has connected more than five million AMI devices across its electric network. The Electric SmartMeter™ Network is working as designed and is delivering substantial benefits in many areas including meter-reading savings, outage notification, faster restoration following outages, power theft identification, and more. As Smart Grid technology evolves, the uses of PG&E's SmartMeter™ Network may evolve as well.

While the most central function of the SmartMeter™ Network is to support day-to-day metering operations, the EPIC 1-14 project demonstrated that these only use about 15-20% of its available bandwidth. This project has shown that there is significant bandwidth available in the network, and that it can support advanced Smart Grid devices and applications – although before deployment these applications will need to go through in-depth bandwidth studies, using the methodology developed in this project. These findings have industry-wide significance, and PG&E has shared them with other IOUs.

As a result of the achievements of this project, PG&E has gained the confidence to:

- Leverage the SMN for Smart Grid devices and applications that have the potential to increase reliability and lower costs.
- Consider deploying Smart Streetlights and low-footprint metering solutions.
- Explore devices that can use the SMN to help monitor the electric distribution system.
- More deeply explore initiatives that leverage SmartMeter™ voltage measurement data, such as exploring algorithmic Phase Identification through an EPIC 2 project.
- Consider methods to make better use of SmartMeter™ outage reporting and logging to immediately identify outages and accurately determine restoration actions in the field.

This project further validated that PG&E's investment in its SmartMeter™ telecommunications network and identified potential ways to extract further value for the company and its customers.

## 8 Glossary

AMI	Advanced Metering Infrastructure
AP	Access Point
Byte	A unit of digital information that most commonly consists of eight bits
CAIDI	Customer Average Interruption Duration Index
CC&B	Customer Care and Billing
CEC	California Energy Commission
CPUC	California Public Utilities Commission
DA	Distribution Automation
dB	Decibels
DMS	Distribution Management System
EOC	Emergency Operations Center
EPIC	Electric Program Investment Charge
4G/LTE	Fourth Generation/Long Term Evolution
FHSS	Frequency Hopping Spread Spectrum.
GIS	Geographical Information System
GoT	Grid of Things™
HAN	Home Area Networking
IDA	Interval Data Analytics
IED	Intelligent Endpoint Device
ILIS	Integrated Logging Information System
IP	Internet Protocol
IPF	Ignore Power Fail
IPv4	Internet Protocol version 4
IPv6	Internet Protocol version 6
kbps	Kilobits per second
kWh	Kilowatt Hours
LED	Light Emitting Diode
MAIFI	Momentary Average Interruption Frequency Index
MDMS	Meter Data Management System
MHz	Megahertz
Mesh Network	A network topology in which each node relays data on the network, cooperating to distribute data in the network.
NAN	Near-Me Area Network
NEM	Network Element Manager
NIC	Network Interface Card
OMS	Outage Management System
OMT	Outage Management Tool
PCT	Programmable Communicating Temperature
PG&E	Pacific Gas and Electric Company
Photocells	A light-sensitive device that can control a switch
Ping	A utility used to test the reachability of a host on an Internet Protocol (IP) network
PKI	Public Key Infrastructure
RF	Radio Frequency

RSSI	Received Signal Strength Indication
RTU	Remote Terminal Unit
SAIDI	System Average Interruption Duration Index
SAIFI	System Average Interruption Frequency Index
SCADA	Supervisory Control And Data Acquisition
SCE	Southern California Edison
SDG&E	San Diego Gas and Electric
SGCL	Smart Grid Communications Lab
SMOC	SmartMeter™ Operations Center
SQL	Structured Query Language
TCP	Transmission Control Protocol
TD&D	Technology Demonstration and Deployment
TMN	Telecommunications Management Network
Trap	A message triggered by an event
UDN	User Data Network
UDP	User Datagram Protocol
Volt/VAR	The process of managing voltage levels and reactive power in power distribution systems
VVO	Volt/VAR Optimization

## Appendix A – Technical Specification Sheet for the GoT™ SmartPole Meter

The Grid of Things™

# SmartPole Meters™

*Enabling the Growth and Operational Efficiency of Connected Cities*

**Innovative Meter Design | Utility Grade Accuracy | Wireless Networking**



- Plug & Twist installation reduces Material and Operation Costs of traditional meters and panels
- Provides solution to accurately monitor small and large loads
- Small footprint allows for installation in confined space



The Grid of Things™  
SmartPole Meters™



## Meter Specifications

- Dimensions: 4.53 in. W x 2.68 in. H
- Parameters Measured: kWh, kW, Voltage, Current, Power Factor and Frequency
- Accuracy: 0.5%
- Power Supply: AC input 85 V-264 V, 50/60 Hz
- Ampere Rating: 16A Max
- Processor: ARM 7, RAM 8 MB, Flash 16 MB
- Data Rate: 50 to 300 kbps
- Frequency Range: 902-928 MHz
- Transmitter Output: 27-30 dBm (1W)

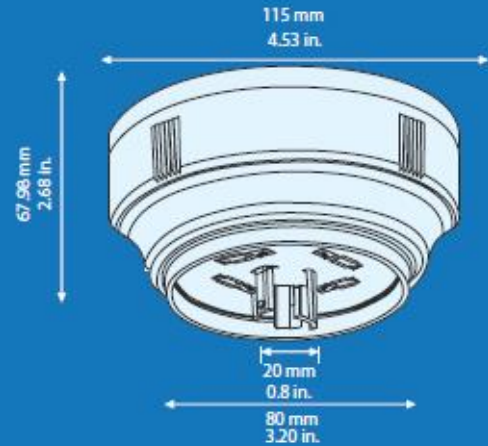

Communicates on electric AMI network and enhances mesh connectivity

Meets ANSI Standards on Safety, Reliability, and Accuracy

Deployed in PG&E service networks

Seamless integration with billing and back office systems

## SmartPole Meter Installation Options



New installation - SmartMeter on top



Existing pole - Retrofit - SmartMeter inside

PRODUCT AT:

**CIMCON**  
Lighting, Inc.

[www.cimconlighting.com](http://www.cimconlighting.com)

**TESCO**

[www.tesco-advent.com](http://www.tesco-advent.com)



The Grid of Things™  
SmartPole Meters™

© 2017 Pacific Gas & Electric Company